

283

267

TC-K5

REVISED

Discard TC-K5 service manual previously issued.

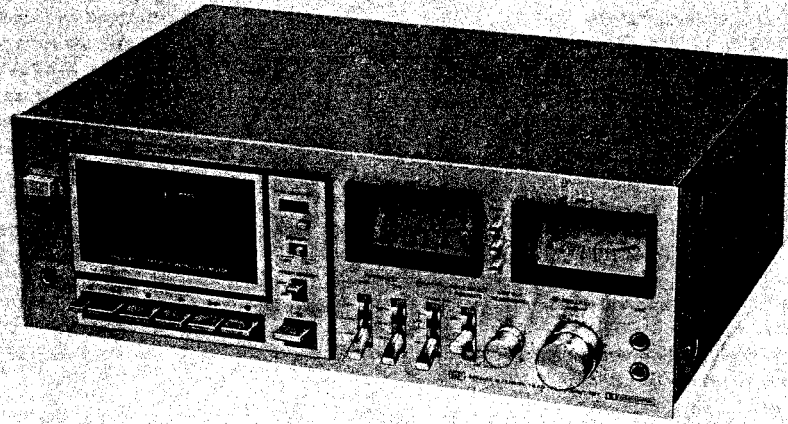

*AEP Model
E Model
US Model
Canadian Model
UK Model*

STEREO CASSETTE DECK

SPECIFICATIONS

Power Requirements: 120V ac, 60Hz (US, Canadian model)
110, 120, 220 or 240V ac, adjustable, 50/60Hz
(AEP, E, UK model)

Power Consumption: 11W (US, Canadian model)
13W (AEP, E, UK model)

Dimensions: Approx. 435 (w) x 145 (h) x 290 (d) mm
17 1/8 (w) x 5 3/4 (h) x 11 1/2 (d) inches
(US, Canadian model)

Approx. 410 (w) x 145 (h) x 290 (d) mm
16 1/8 (w) x 5 3/4 (h) x 11 1/2 (d) inches
(AEP, E, UK model)

Weight: Approx. 6.9kg (15 lb 4 oz)
(US, Canadian model)

Approx. 6kg (13 lb 4 oz)
(AEP, E, UK model)

Track: 4-track 2-channel stereo

Fast Forward and Rewind Time: Approx. 90 seconds with Sony cassette C-60

Frequency Response: DOLBY NR OFF

With Ferri-Chrome cassette
20-18,000Hz (NAB)
30-16,000Hz ± 3dB (NAB)
30-16,000Hz (DIN)

With chromium dioxide cassette
20-17,000Hz (NAB)
30-15,000Hz ± 3dB (NAB)
30-15,000Hz (DIN)

With regular cassette
20-15,000Hz (NAB)
30-13,000Hz (DIN)

'Dolby' and the double-D symbol are the trade marks of Dolby Laboratory Inc. Noise reduction system manufactured under license from Dolby Laboratory Inc.
0 dB = 0.775V

- Continued on page 2 -

SONY®

SERVICE MANUAL

Wow and Flutter: 0.05% wrms (NAB)
±0.14% (DIN)

S/N Ratio: DOLBY NR OFF
With Ferri-Chrome cassette
59dB at peak level (NAB)
57dB (DIN, 1975 rev.)
49dB (DIN, old)
With chromium dioxide cassette
55dB at peak level (NAB)

DOLBY NR ON
Improved by 5dB at 1kHz,
10dB above 5kHz

Total Harmonic Distortion: 1.3%

Record Bias Frequency: 105kHz

Inputs: Microphone inputs (two phono jacks)
sensitivity: 0.25mV (-70dB)
for a low-impedance microphone
Line inputs (two phono jacks)
sensitivity: 77.5mV (-20dB)
input impedance: 100kΩ

Outputs: Variable line outputs (two phono jacks)
output level: 0.775V (0dB)
at load impedance 100kΩ
with LINE OUT level control at "10"
suitable load impedance: more than 10kΩ
Fixed line outputs (two phono jacks)
output level: 0.435V (-5dB)
at load impedance 100kΩ
suitable load impedance: more than 10kΩ
Headphone output (binaural jack)
output level: -20 to -50dB
at load impedance 8Ω

Record/playback Jack: Input impedance: less than 10kΩ
Output impedance: less than 10kΩ

0dB = 0.775V

MODEL IDENTIFICATION

Specification label

E, AEP, UK model

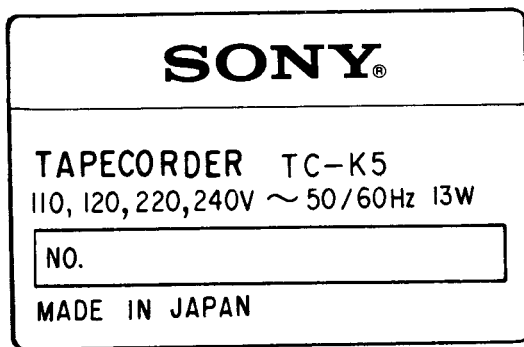

US, Canadian model

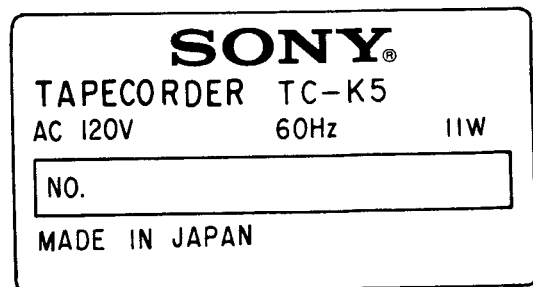

— Power Cord —

E model: euro-plug (Part No. 1-551-216-11)

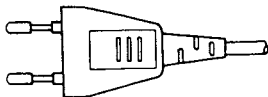

E model: parallel blade plug (Part No. 1-534-754-14)



SECTION 1
OUTLINE

1-1. BLOCK DIAGRAM

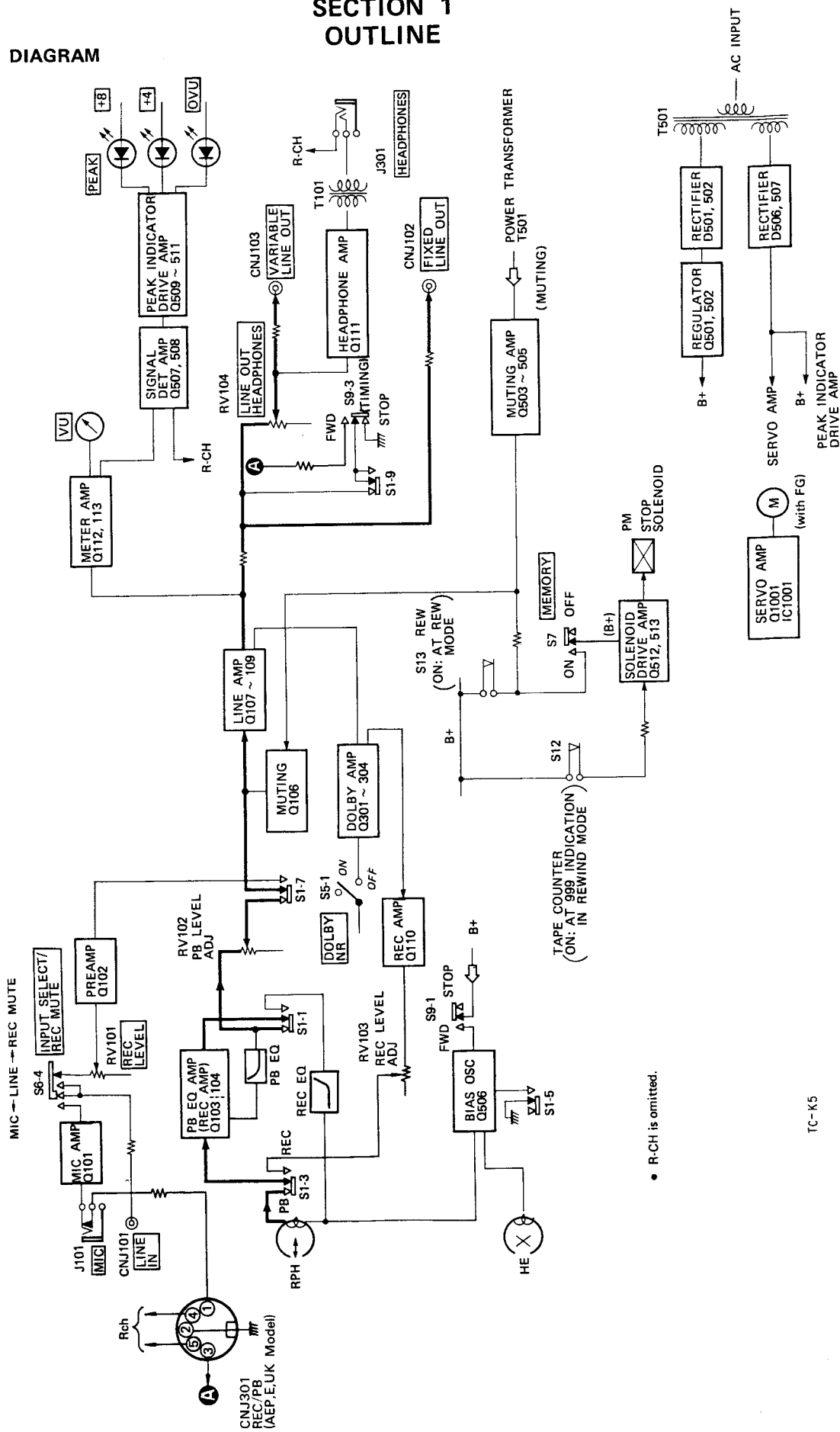

• R-CH is omitted.

1-2. MECHANICAL OPERATION

Full-Auto Shut-Off Mechanism

When the end of the tape has been reached and the take-up reel stops rotating, shut-off lever (B) pushes against button-lock plate (A), thereby releasing the function buttons and bringing the motor to a stop.

Operation in Forward and Fast Forward Modes

(See Fig. 1-1.)

1. The mechanical parts rotate in the directions shown by the numbered arrows ① - ④ .
2. Detecting lever (B) is pushed aside in the direction of arrow ⑤ due to the rotational action of the take-up reel.
3. The tip of detecting lever (B) is pushed into a central position (shown by dotted line) by the guide ⑥ of worm wheel. However, once the guide ⑥ has passed, the rotating take-up reel spindle pulls the detecting lever (B) back across to the right ⑤ , thereby maintaining the forward (or fast forward) mode.

in forward or fast forward mode

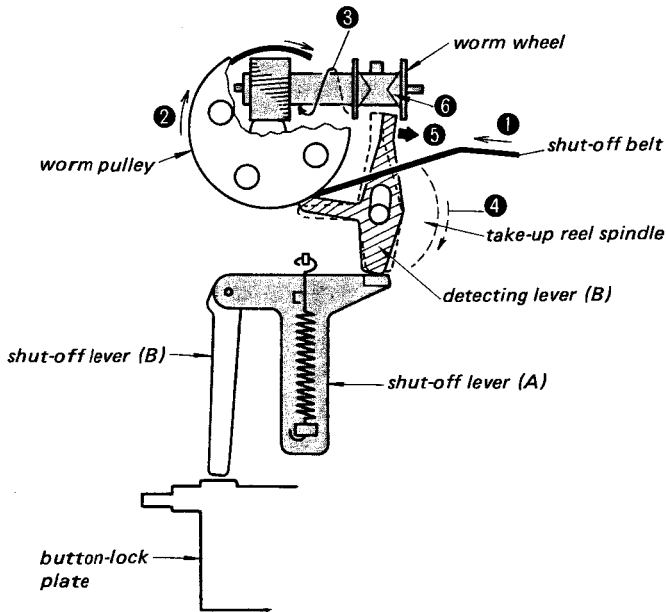

Fig. 1-1.

At the End of the Tape (in fast forward and forward modes)

When the take-up reel stops rotating, the worm wheel activates the automatic shut-off mechanism. This operation is made by shut-off lever (B) pushing against button-lock plate (A) as shown in Fig. 1-2.

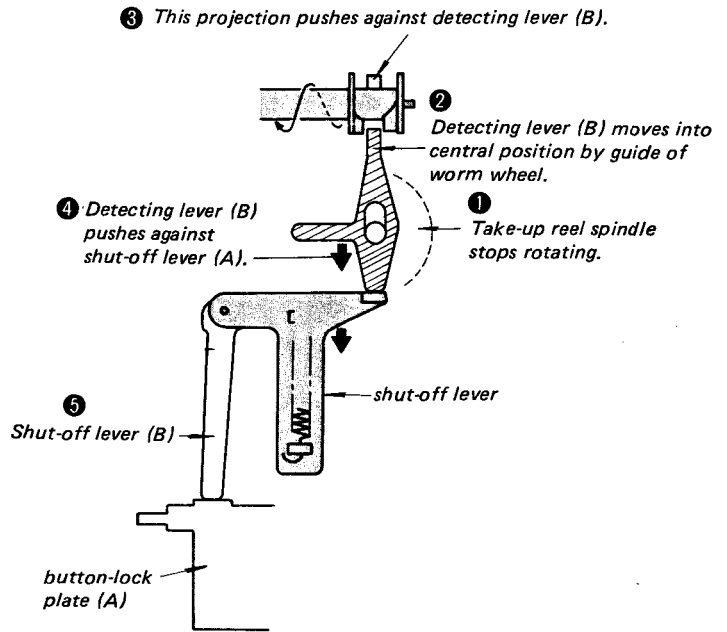

Fig. 1-2.

In Rewind Mode

The tip of detecting lever (B) is pushed to the left side of the worm wheel by the take-up reel rotating in the reverse direction. When the take-up reel stops rotating, button-lock plate (A) is pushed again back as in forward and fast forward modes, resulting in the release of the transport mode and stopping of the motor rotation.

Pause in Forward Mode

(See Fig. 1-3.)

As pause spring pushes detecting lever (B), the automatic shut-off mechanism does not operate.

in pause mode

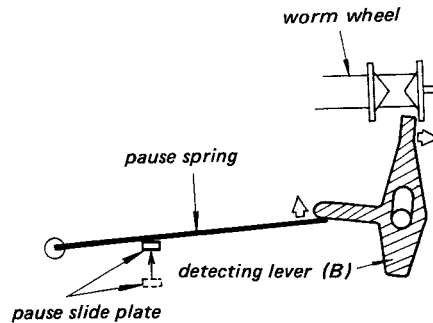

Fig. 1-3.

Auto-Play Mechanism

(See Fig. 1-4.)

When the forward and rewind buttons are pressed at the same time, the tape deck is in rewind mode. When the tape has been wound onto supply reel and the reel stops rotating, only the rewind button is released, resulting in forward mode commencing automatically.

Note: When these two buttons are pressed at the same time, both forward and rewind modes are initiated. However, the auto-play lever prevents the pinch roller from pressing against the capstan. As a result, rewind mode will take priority. (The auto-play lever is not shown in Fig. 1-4.)

In Rewind Mode of Auto-Play Phase

(See Fig. 1-4.)

1. The FR lever pushes gear (A) to engage the flywheel gear, thereby driving the supply reel spindle, and resulting in rewinding of the tape.
2. The rod of the FR lever (C) displaces the button-lock plate spring (A) from its normal position, thereby separating button-lock plate (B) (E) from button-lock plate (A) (D).
3. The take-up reel spindle rotates in the direction shown by the arrow, thereby preventing the shut-off mechanism from being activated.

4. The auto-play lever prevents the pinch roller from pressing against the capstan, but the tape is near the head ready to commence forward mode.

At the End of Tape in Rewind Mode

1. When the take-up reel stops rotating, the shut-off mechanism is activated. The button-lock plate (A) is pushed back, and the rewind button consequently released.
2. Gear (A) disengages the flywheel gear, thereby releasing rewind mode.
3. Since the button-lock plate spring has been displaced by the FR lever rod, button-lock plate (B) employed to release the forward button will remain where it is at this time. Therefore, at the end of the rewind mode, only the rewind button is released. Forward mode is then commenced automatically.

At the End of Tape in Forward Mode

1. The FR lever rod is withdrawn as soon as forward mode is commenced. Consequently, the both button-lock plates (A) and (B) are engaged again by the button-lock plate spring.
2. When the shut-off mechanism is activated again at the end of tape in forward mode, both button-lock plates (A) and (B) are pushed back by FR lever rod, thereby bringing all transport mechanism to a complete stop mode.

in rewind mode

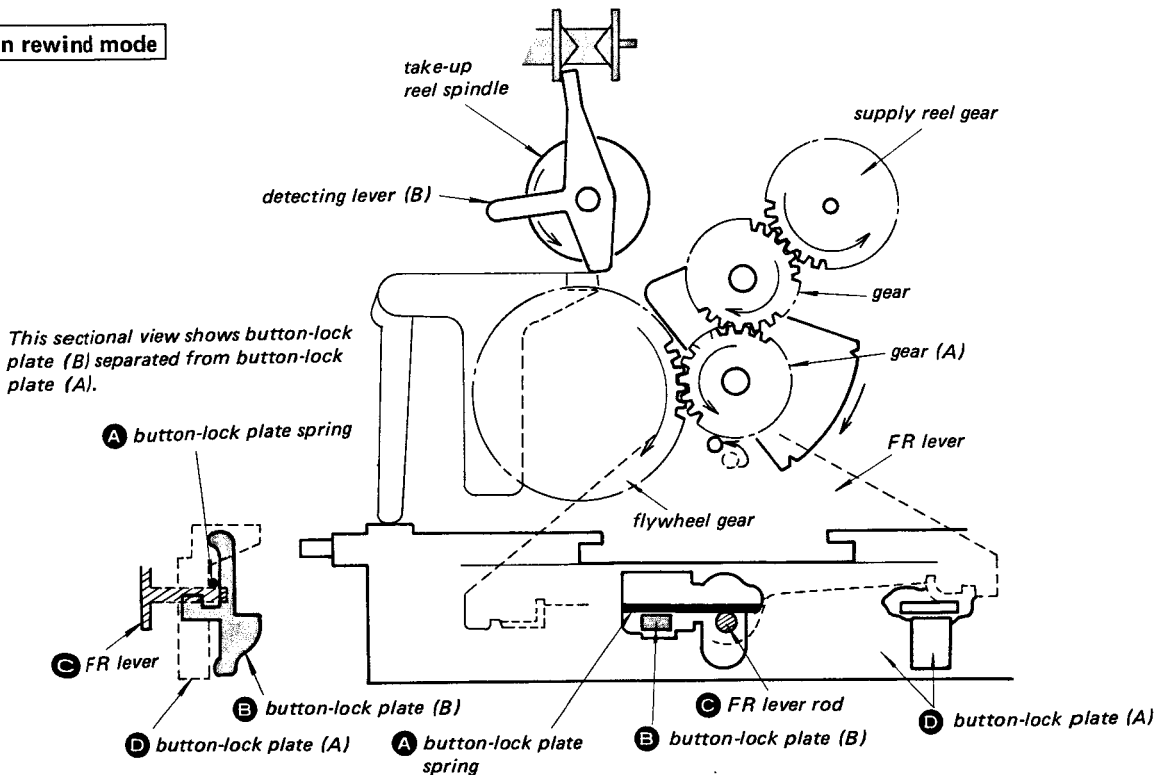

Fig. 1-4.

Timer Standby Mechanism

The timer standby switch permits playback or record mode to be commenced at desired time. With the power cord of the tape deck disconnected from the ac wall outlet, turn the power switch on, and press the forward button, or the forward and record buttons. Then, turn the timer standby switch on, and connect the tape deck to the ac wall outlet through a timer for the desired time.

At Standby

(See Fig. 1-5.)

1. The timer standby switch presses up against the timer standby levers (A) and (B).
2. The pause slide plate and release lever are thereby moved in the direction shown by the arrows marked ▲, resulting in the pinch roller being separated from the capstan.
3. The timer standby lever (B) presses up against the release lever (A), thereby separating the take-up arm pulley from the tire of the take-up reel spindle.
4. The timer standby lever (A) pushes timer standby lever (C) in the direction of arrow ①, thereby pushing shut-off lever (B) (employed to release function buttons) away from the button-lock plate (A).

at standby mode

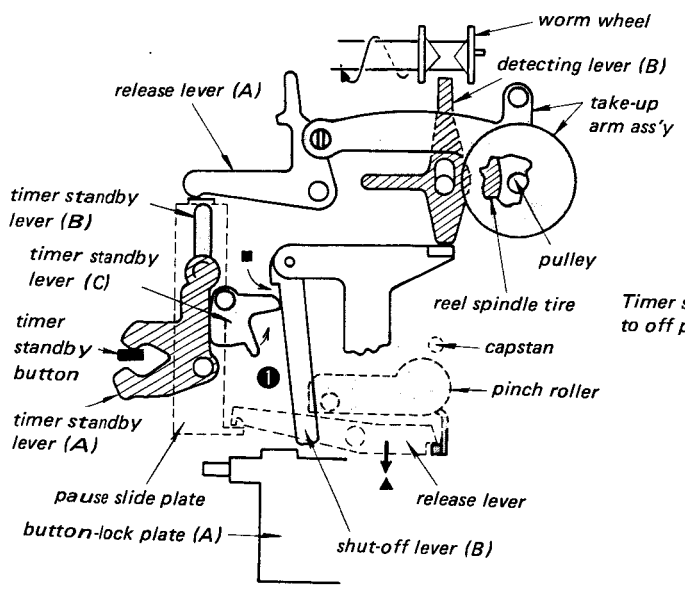

Fig. 1-5.

When Power is Switched On

(See Fig. 1-6.)

1. The motor starts to drive the worm wheel.
2. The worm wheel pushes against detecting lever (B).
3. The ■ marked section of shut-off lever (B) pushes against standby lever (C) as shown in Fig. 1-5.
4. The timer standby lever (C) pushes against standby lever (A), thereby returning the timer standby button to the off position.
5. The timer standby lever (B) and release lever (A) return to their original positions, thereby bringing the take-up arm to engage against the tire of the take-up reel spindle which is rotated by motor.
6. Since the pause slide plate and release lever also return to their original positions, the pinch roller presses against the capstan to start forward mode.

when power switched on

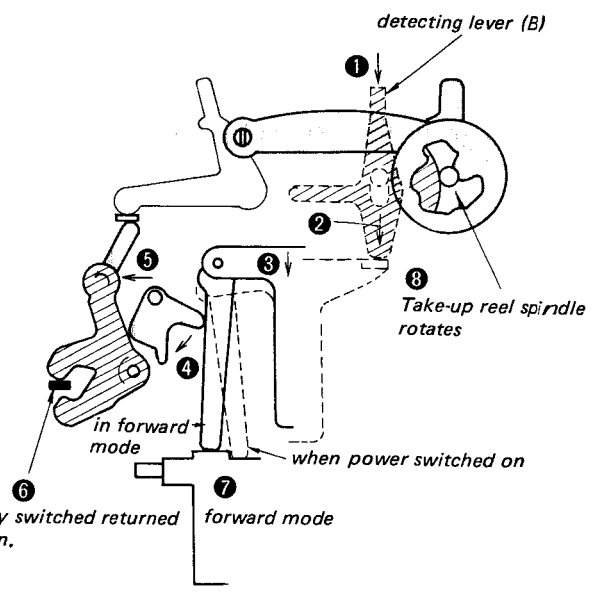

Fig. 1-6.

1-3. CIRCUIT DESCRIPTION

Peak Level Indicator

The signal levels in both left and right channels are monitored simultaneously. The instantaneous peak levels that the level meters cannot follow are displayed by mean of the three LED peak level indicators. The three peak levels displayed are: 0 VU, +4 and +8

Peak Level Indication Circuit

(See Fig. 1-8.)

1. Q507 and Q508 are employed in signal level detection and peak level holding.
2. If an input signal in the left channel instantaneously reaches a level of 1.2V, Q507 will charge up C517 immediately to 0.6V.
3. Even after the signal pulse has passed, the charged C517 will indicate the peak value.
4. The C517 discharges relatively slowly through resistors R connected in parallel. Therefore, the transient peak level can be monitored by the peak indicating LEDs.

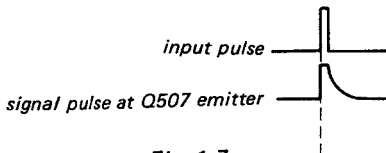

Fig. 1-7.

5. When the emitter voltage of Q507 is more than 0.6V, a signal is passed through R1 to turn Q509 on, and illuminates the 0 VU indicating LED.
6. Hence, an input signal of 1.2V results in the 0 VU indicating LED illuminating. For transient input signals of which levels are +4 and +8dB higher than 1.2V, the respective +4 and +8dB indicating LEDs will illuminate.

In Case that Left and Right Input Signal Levels are different

The transistor with the higher base potential of left and right channels is turned on.

The transistor of the low level channel will be turned off because its emitter voltage is raised by emitter voltage of transistor with a higher level.

In case of Same-Level, In-Phase Input Signals in Both Left and Right Channels

Both Q507 and Q508 are activated simultaneously by identical input signals. The peak detection circuitry has been designed to maintain C517 at levels 0.6V below the input levels.

Base Resistors R185 and R285

R185 and R285 are connected to the bases of Q507 and Q508 to protect these transistors, and Q113 and Q213 in the drive stage, from destruction.

With the emitters connected to a capacitor C517, and the collectors connected to the B+ bus as shown in Fig. 1-7, the current flow in transistor could easily exceed maximum I_c when transient input peaks are applied without any resistance to restrict the current flow, resulting in destruction of the transistors. Therefore, R185 and R285 are used to limit I_c .

Recording Amplifier

During recording, the TC-K5 employs the playback equalizer amplifier as the final stage of the recording amplifier in record mode.

Dolby Circuit

The Dolby circuit employed in the TC-K5 is of the standard type feedback operation in playback mode, and pass-through operation in record mode.

Peak Level Indication Circuit

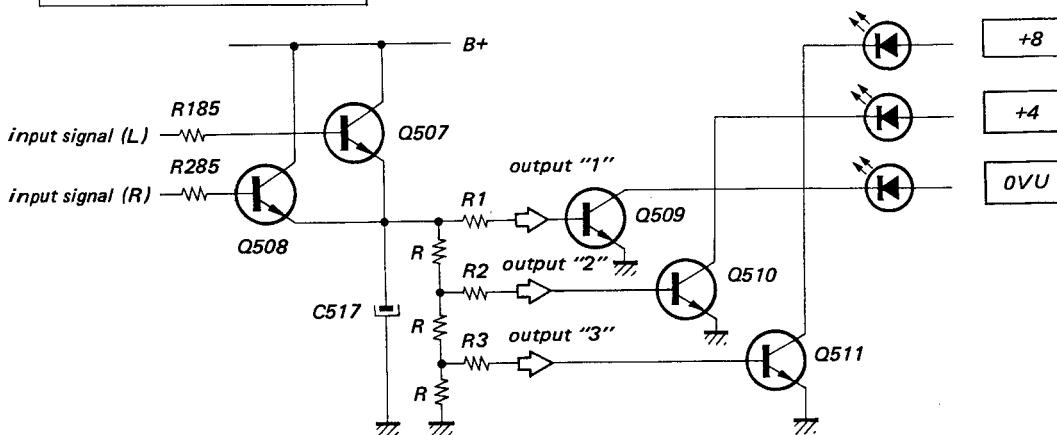

Fig. 1-8.

1-4. CHASSIS

The chassis of the TC-K5 features a new structural design, employing molded bosses and plates, etc. on both sides of the main metal frames. All molded units are interconnected with each other by thin strips. These inter-connecting pieces help to stabilize the molded units, and therefore should not be forced aside or pulled out like other movable parts.

The chassis consists of two main metal frames. The reel spindle and their drive gears, and part of the shut-off mechanism are mounted on the smaller, detachable frame. The Fig. 1-9 and Fig. 1-10 show the relative positions of parts when tape transport mechanism is in stop mode.

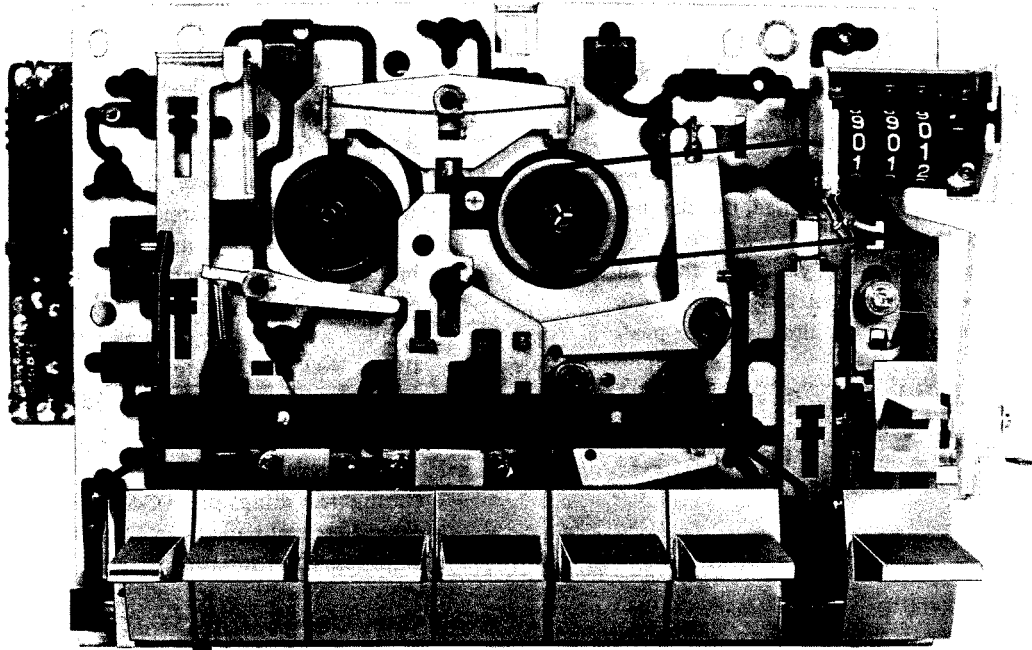

Fig. 1-9.

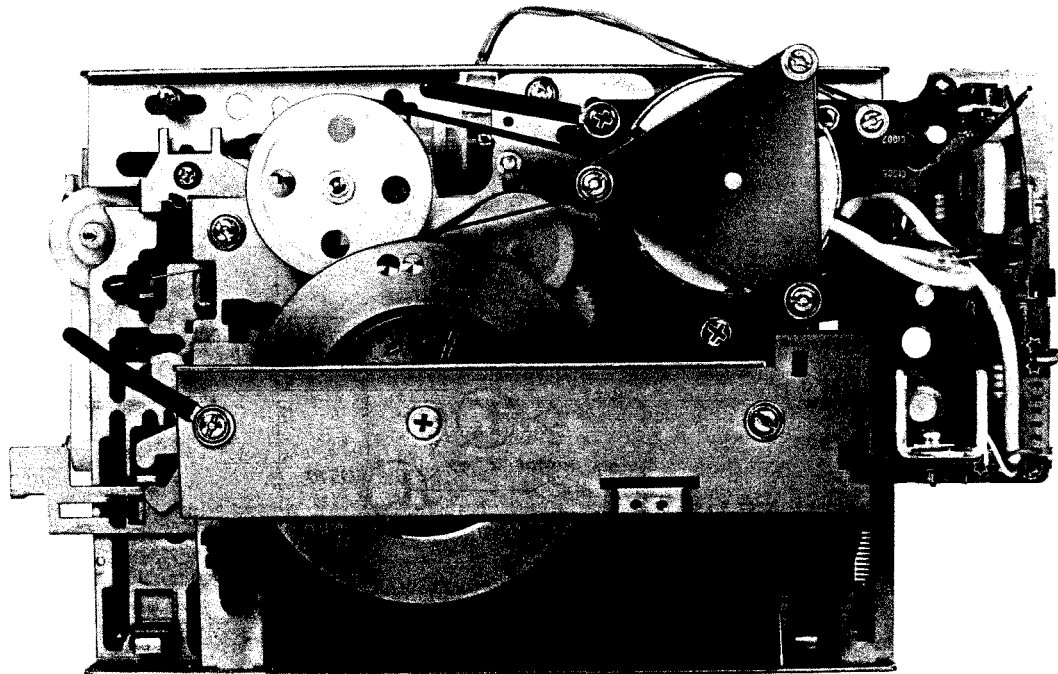
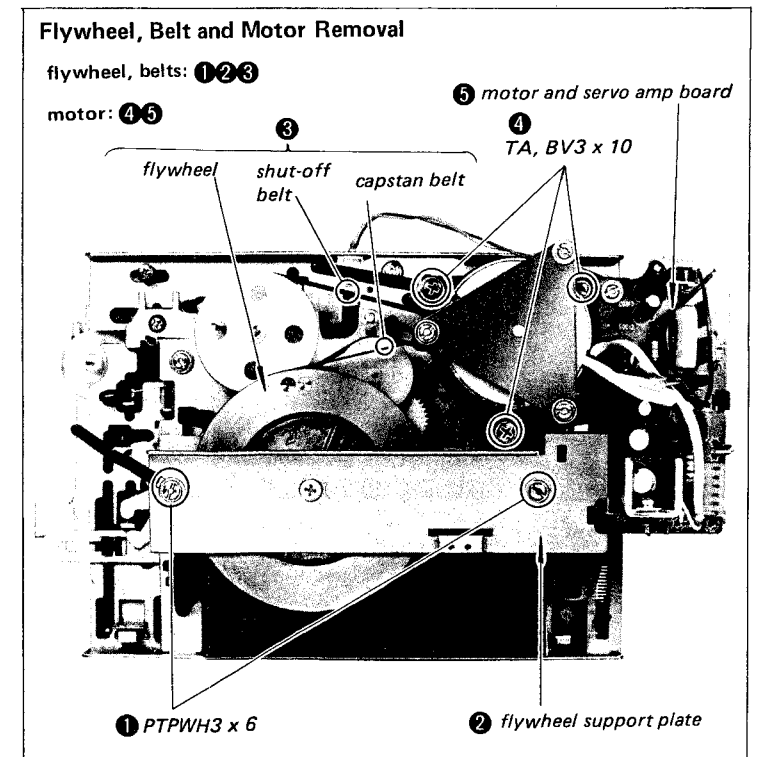
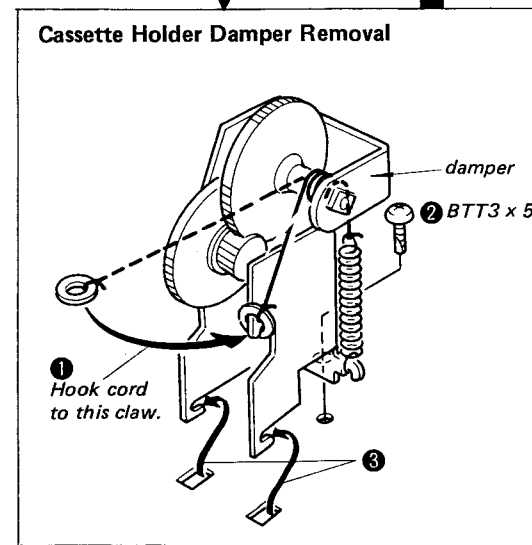
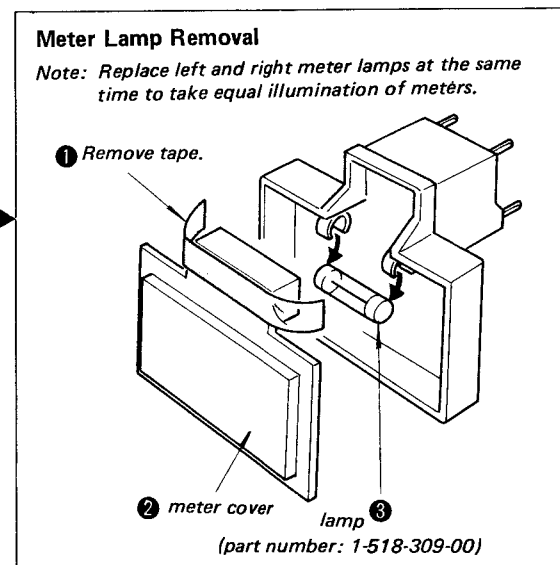
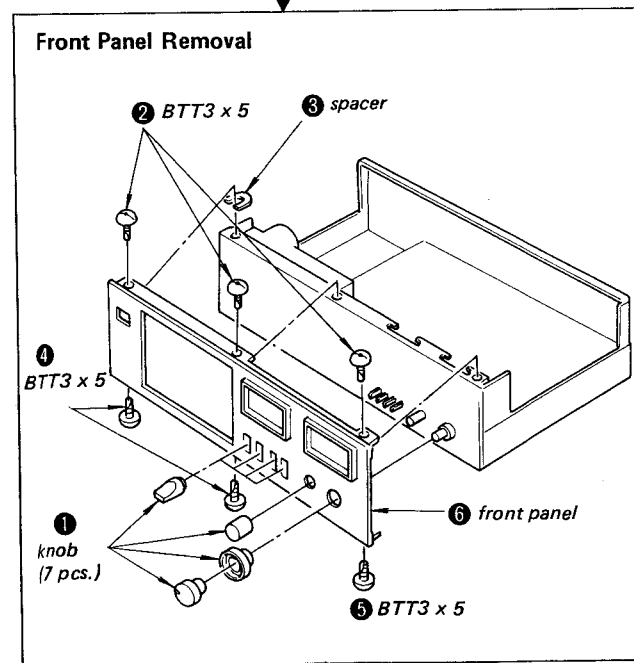
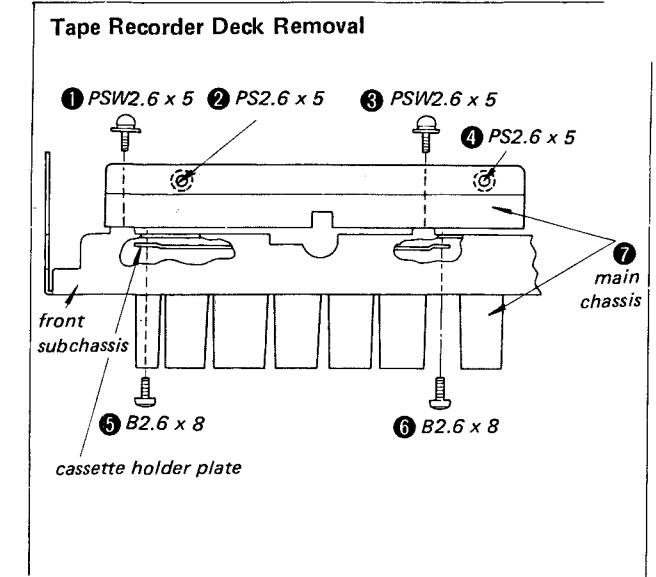
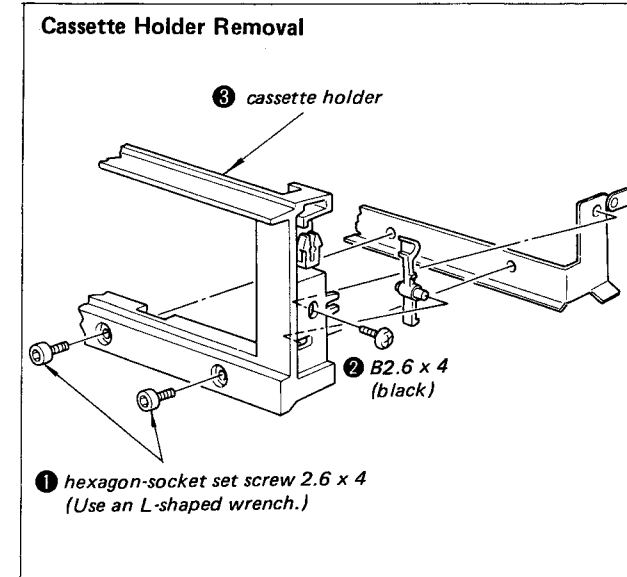
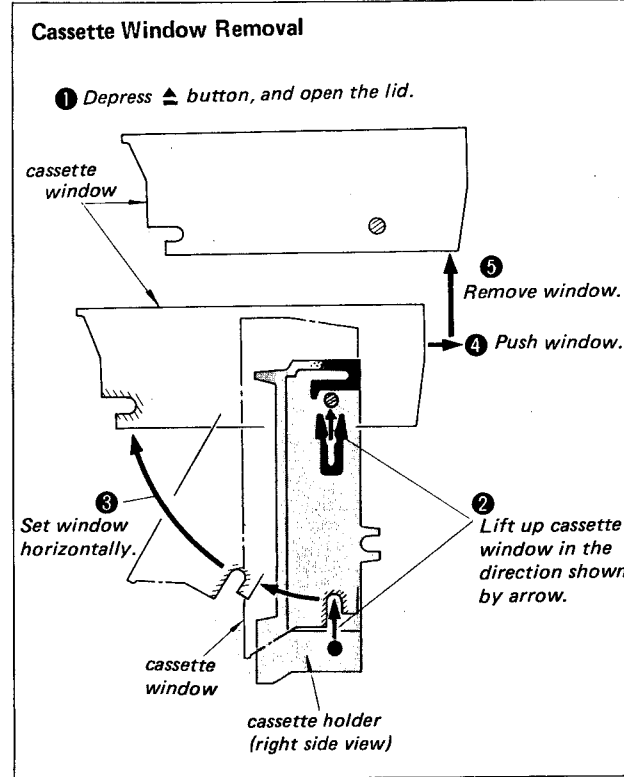
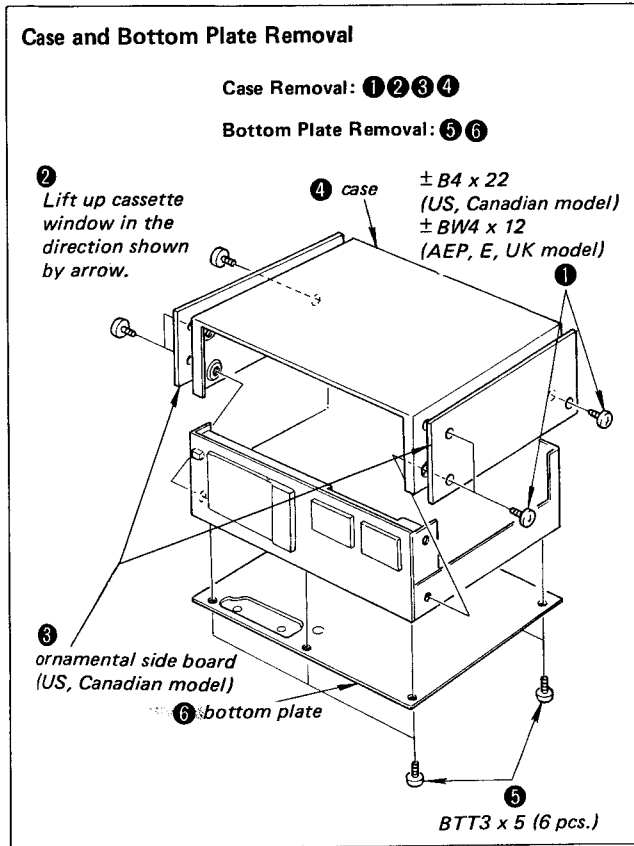

Fig. 1-10.

SECTION 2
DISASSEMBLY

Follow the disassembly procedure in the numerical order given.



Spindle Chassis Ass'y Removal

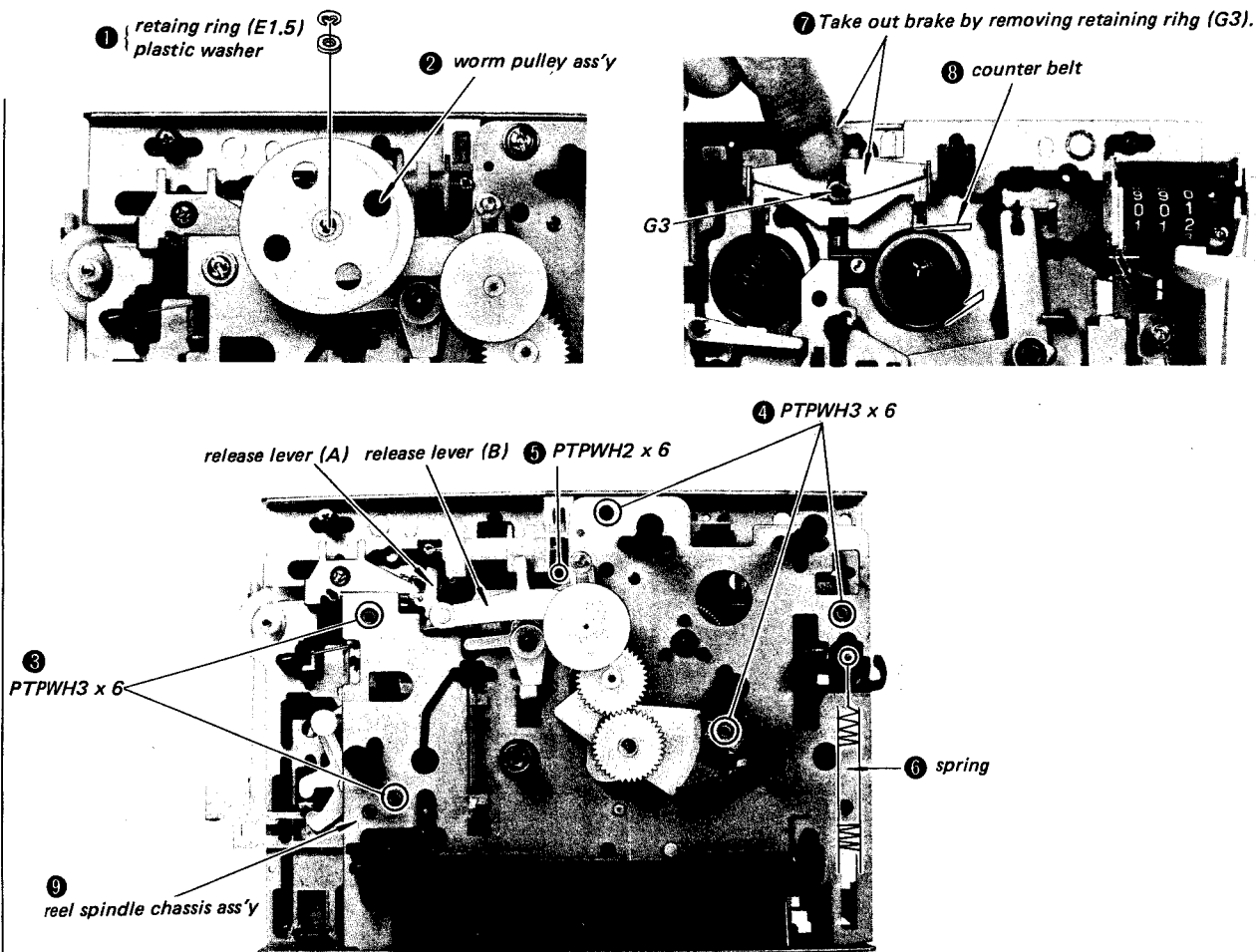

Caution on Reel Spindle Chassis Installation

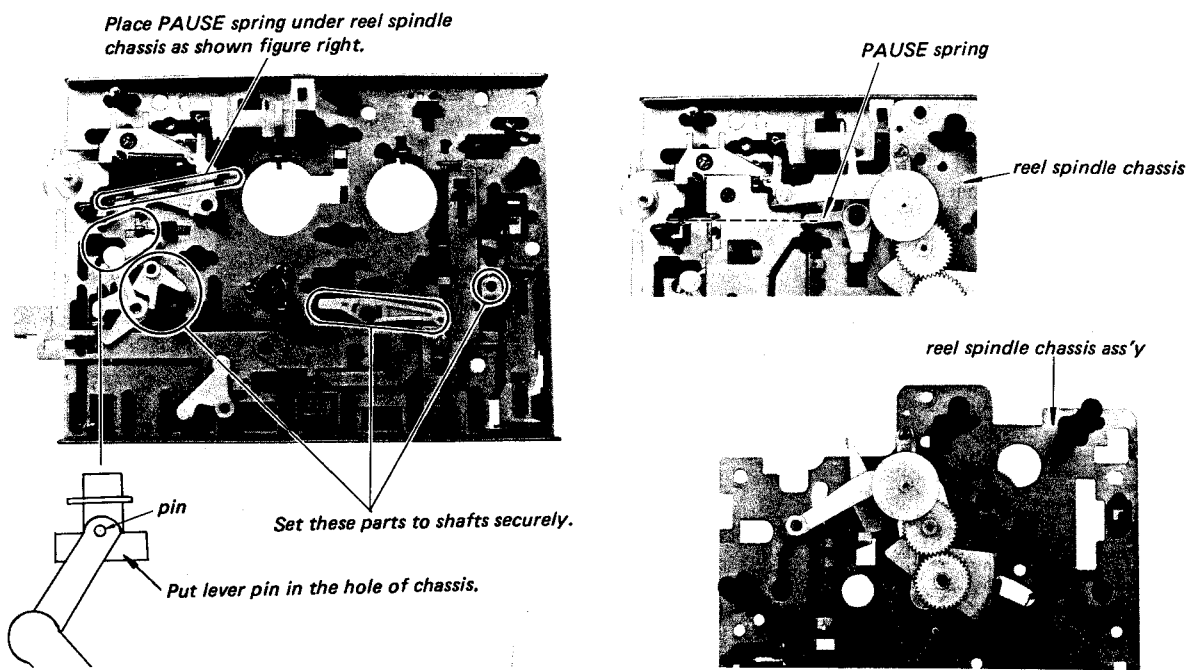

Reel Table Removal

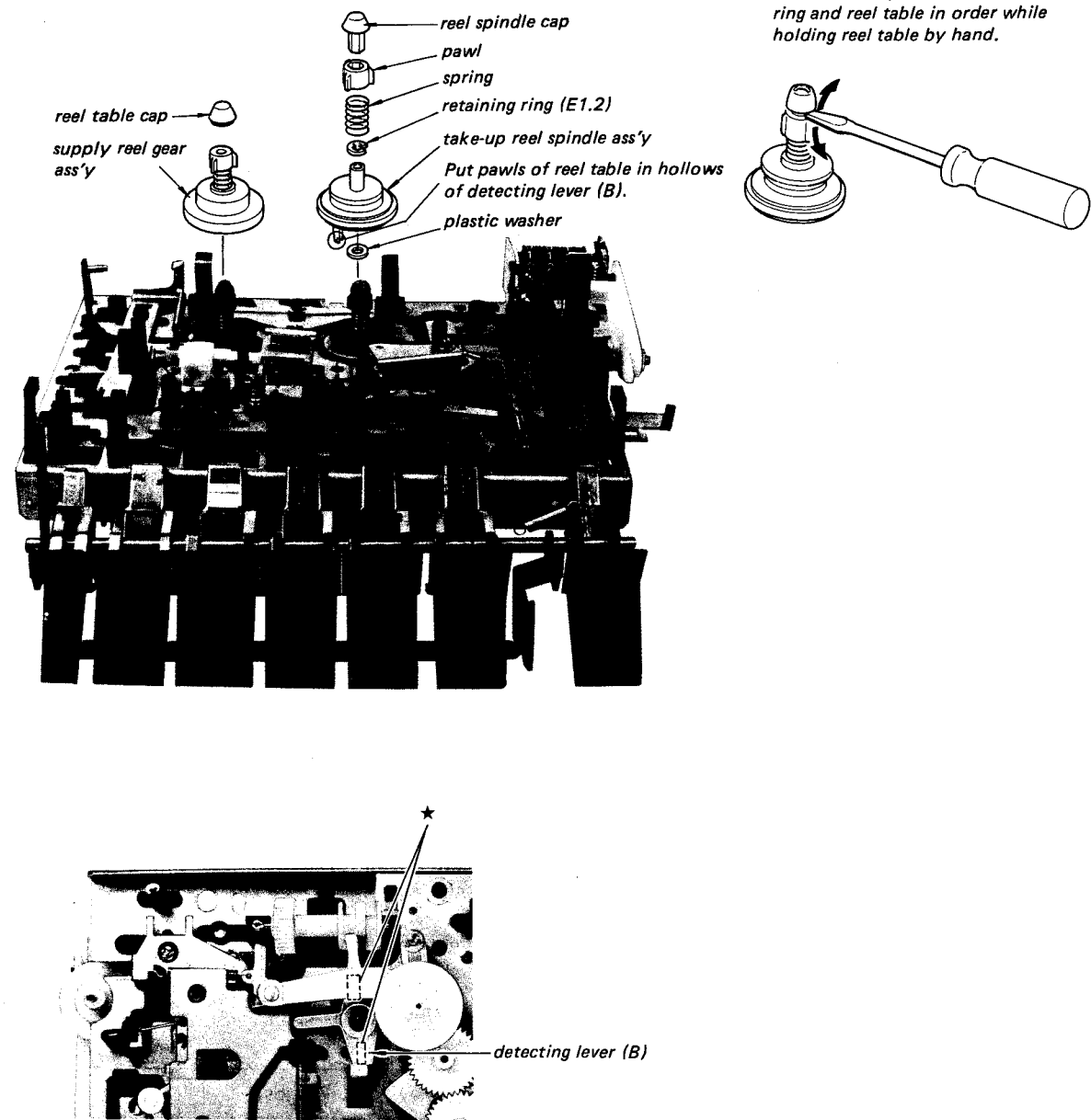

SECTION 3 ADJUSTMENTS

3-1. MECHANICAL ADJUSTMENTS

PRECAUTION

1. Clean the following parts with a denatured-alcohol-moistened swab:

| | |
|----------------------|--------------|
| record/playback head | pinch roller |
| erase head | rubber belts |
| capstan | idlers |
2. Demagnetize the record/playback head with a head demagnetizer.
3. Do not use a magnetized screwdriver for the adjustments.
4. After the adjustments, apply suitable locking compound to the parts adjusted.
5. The adjustments should be performed with the rated power supply voltage unless otherwise noted.

Forward Tension Torque Adjustment — playback mode —

Use type CQ-102A cassette torque meter.
Specification: 2.0 – 4.5g·cm
(0.02 – 0.06 oz·inch)

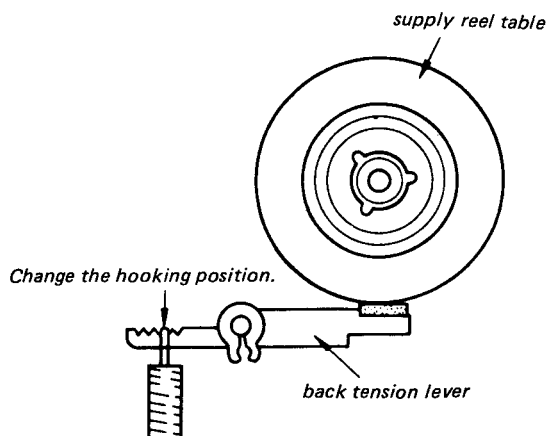

Tape Path Adjustment

1. Make an adjustment cassette as shown below.

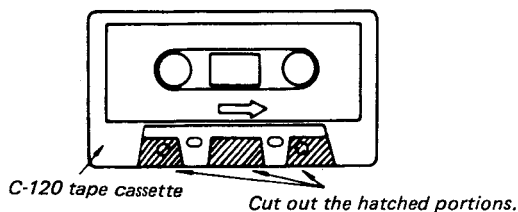

2. While viewing from the top, adjust the head heights to eliminate tape curl and tape twist at arrowed portions.

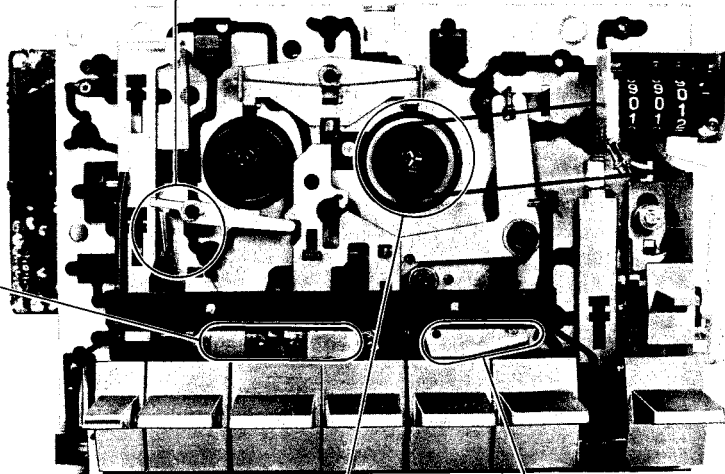
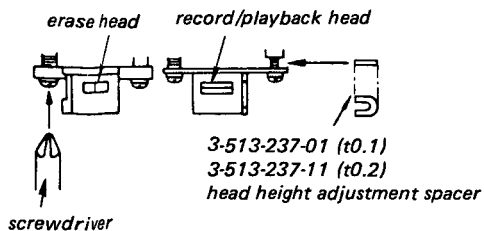
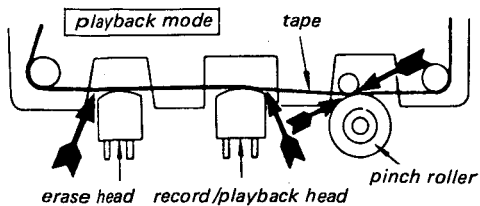

Forward Torque Adjustment — playback mode —

| Torque meter | Meter reading |
|--------------|--------------------------------------|
| CQ-102A | 30 – 50g·cm (0.41 – 0.69 oz·inch) |

If necessary, change the spring position.

take-up reel spindle

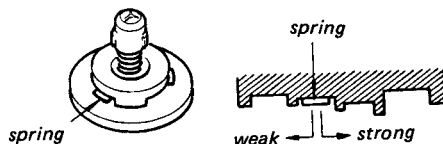

Pinch Roller Pressure Measurement — playback mode —

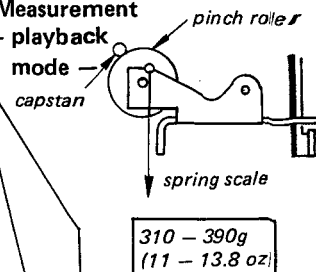

Hold Switch (S14) Position Adjustment
 — stop mode —

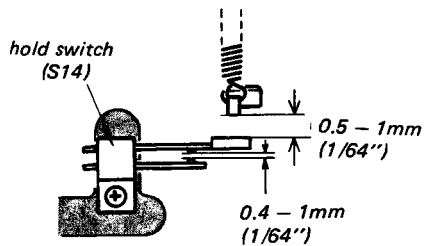

Motor (S10) and REW (S13) Switch Position Adjustments
 — stop mode —

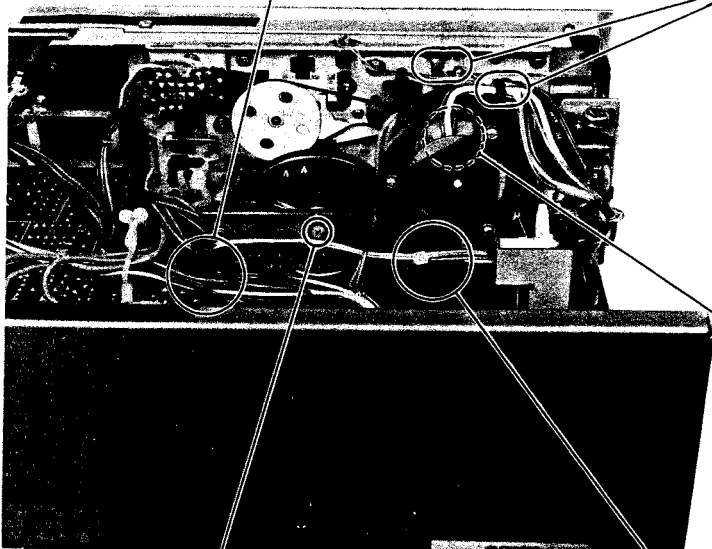
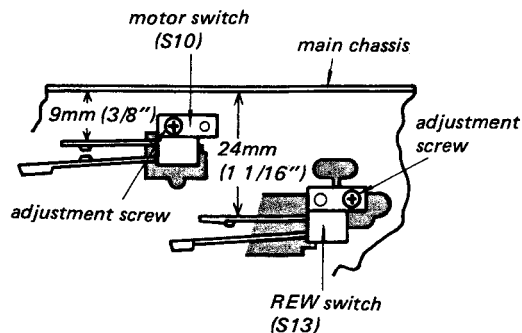

Pulley Height Adjustment
 — stop mode —

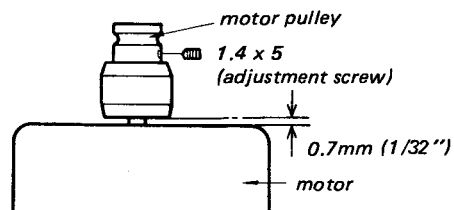

Thrust Adjustment
 — playback mode —

1. Connect a dc voltmeter across the motor.
2. Turn the screw clockwise for the position where the meter reading suddenly increases.
3. Loosen the screw ¼ turn from the position obtained in step 2.

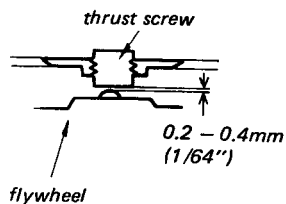

Muting Switch (S11) Position Adjustment
 — stop mode —

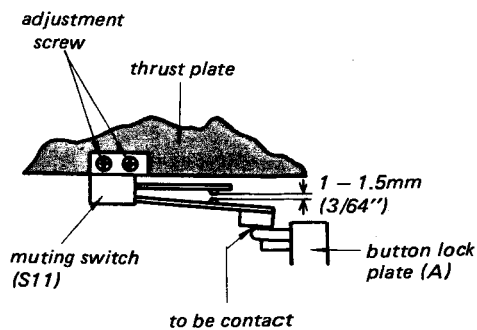

3-2. ELECTRICAL ADJUSTMENTS

Note: The adjustment should be performed in the order given in this service manual. The adjustments should be performed for both L-CH and R-CH.

Test Equipment/Tools Required:

- audio oscillator (af osc)
- VTVM
- digital frequency counter
- speed checker SONY LFM-30
- oscilloscope
- attenuator (600Ω)
- non-magnetic screwdriver
- resistors ... 600Ω (¼W), 10kΩ (¼W), 100kΩ (¼W)
- blank tapes (completely erased with bulk eraser)
SONY CS-10 (HF), CS-20 (CrO₂), CS-30 (Fe-Cr)

BIAS and EQ switch settings in accordance with tape used are as follows.

| Tape | BIAS switch | EQ switch |
|-------|-------------|------------------|
| CS-10 | NORMAL | NORMAL |
| CS-20 | HIGH | CrO ₂ |
| CS-30 | NORMAL | Fe-Cr |

SONY test tapes

- P-4-A81S (6.3kHz, -10dB)
- P-4-A81 (6.3kHz, -10dB)
- P-4-L81 (333Hz, 0dB)
- WS-48 (3kHz, 0dB)

Switches and controls should be set as follows unless otherwise specified.

- DOLBY NR switch: OFF
- EQ switch: NORMAL
- BIAS switch: NORMAL
- LINE OUT/HEADPHONES LEVEL: MAX
- TIMER STANDBY switch: OFF
- MEMORY switch: OFF
- REC MUTE switch: OFF

Test Equipment Connections:

Input side:

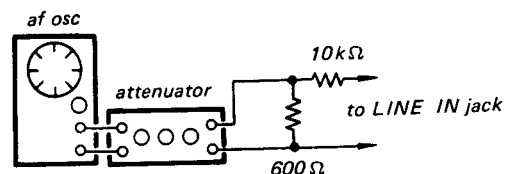
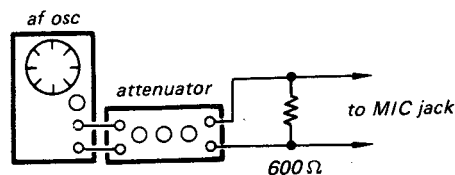

Standard Record:

Deliver the standard input signal level to the input jack and set the REC LEVEL control to obtain the standard output signal level.

Standard Input Level

| | MIC | LINE IN |
|------------------|----------------|---------------|
| source impedance | 300Ω | 10kΩ |
| input level | 0.77mV (-60dB) | 0.25V (-10dB) |

Standard Output Level

| | LINE OUT (FIXED) | HEADPHONES |
|----------------|------------------|--------------|
| load impedance | 100kΩ | 8Ω |
| output level | 0.44V (-5dB) | 39mV (-26dB) |

Record/playback Head Azimuth Adjustment

Procedure:

1. Mode: Playback

test tape
P-4-A81S
(6.3kHz, -10dB)

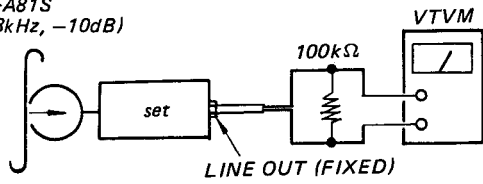

2. Turn the adjustment screw for maximum level and set it to the mechanical mid position between L-CH and R-CH peak positions.

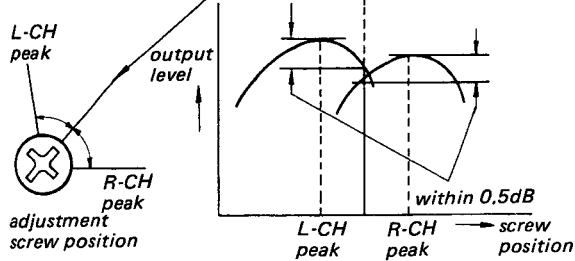

3. Mode: Playback

test tape
P-4-A81S
(6.3kHz, -10dB)

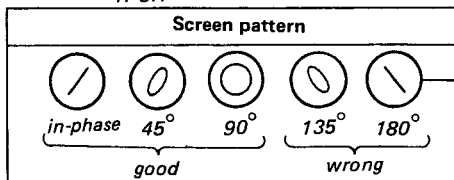
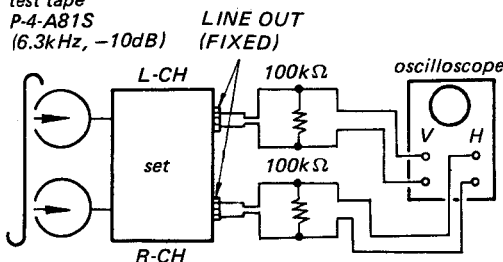

Adjustment Location:

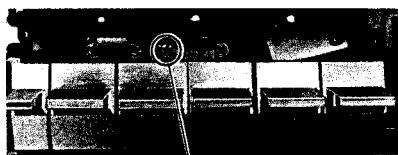

adjustment screw

Tape Speed Adjustment

Procedure:

- Mode: Playback

speed checker
LFM-30
or
digital frequency
counter

WS-48
(3kHz, 0dB)

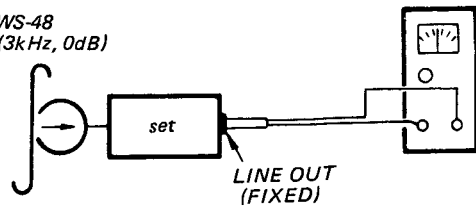

Adjust RV1001 to obtain the specified values below.

Specification:

| Speed checker | Digital frequency counter |
|---------------|---------------------------|
| -0.7 ~ +0.7% | 2,980 ~ 3,020Hz |

Frequency difference between beginning and end of tape should be within 0.7% (20Hz).

Adjustment Location:

- servo amp board -

RV1001

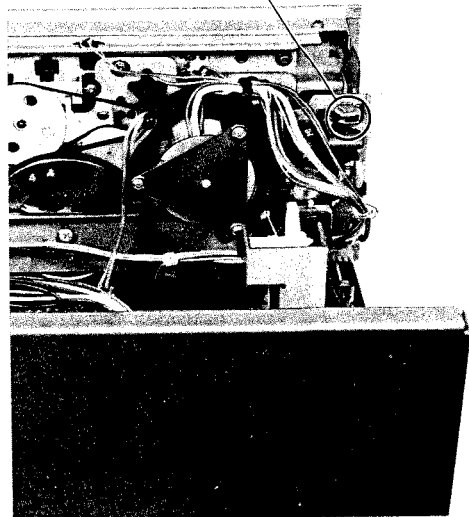

Playback Level Adjustment

Procedure:

1. Mode: Playback

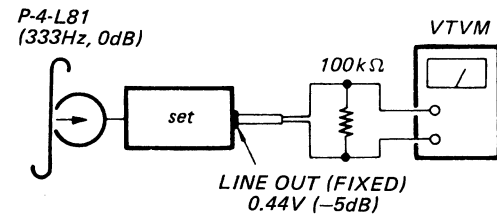

Adjust RV102 (L-CH) and RV202 (R-CH) to obtain 0.44V (-5dB) VTVM reading.

2. Assure that the LINE OUT level does not change when the mode is changed from playback to stop several times.

Specification:

LINE OUT level: 0.42-0.47V
(-4.5 to -5.5dB)

Adjustment Location:

- record/playback amp board -

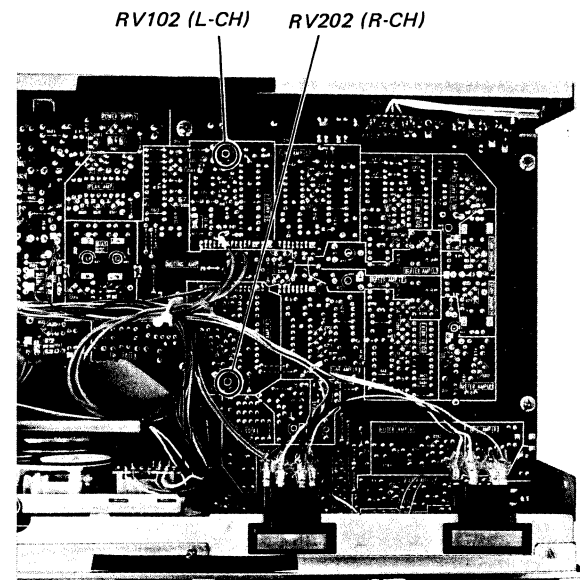

Playback Equalizer Adjustment

Procedure:

- Mode: Playback

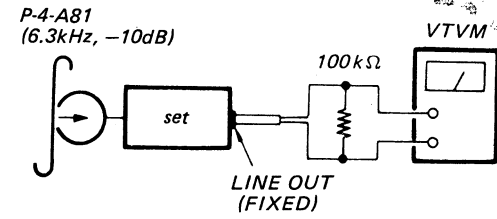

Adjust pattern connections for 0.12-0.16V (-13.5 to -16.5dB) VTVM reading.

Adjustment Location:

- record/playback amp board -

| Pattern connection | High frequency level |
|--------------------|----------------------|
| (open) | ↑ up |
| Ⓐ | ↑ ↓ |
| Ⓐ and Ⓑ | |

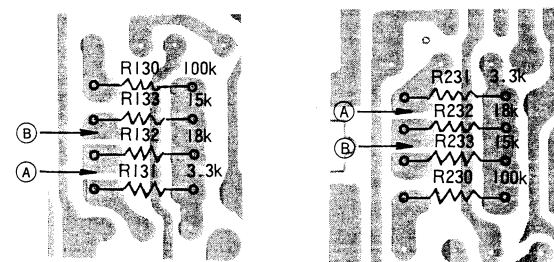
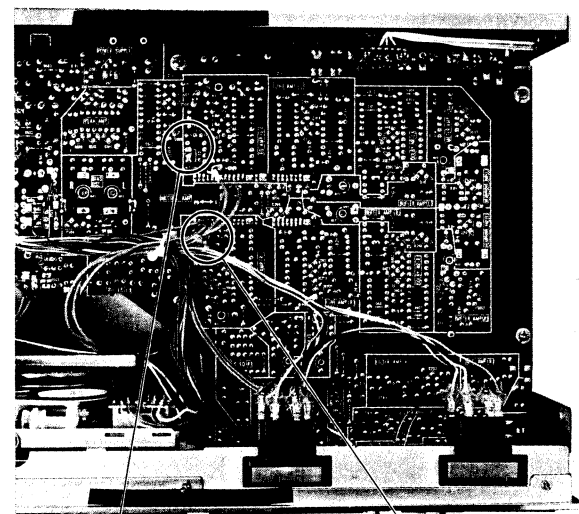

Note: After this adjustment, confirm the playback level.

Record Bias Adjustment

Procedure:

1. Mode: Standard record (See page 15.)

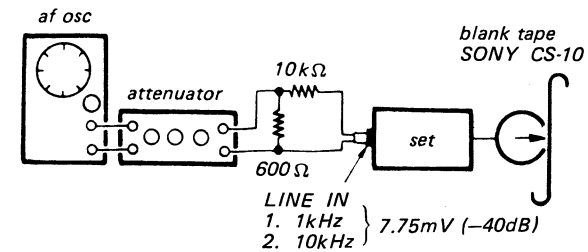

2. Mode: Playback

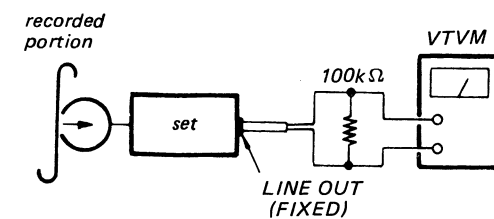

Adjust C128 (L-CH) and C228 (R-CH) to make 10kHz and 1kHz signal output levels equal.

Adjustment Location:

Note: Normally, patterns at Ⓐ are bridged. If adjustment is not made with trimmers fully tightened, remove solder bridge at Ⓐ and connect patterns at Ⓑ, and repeat the adjustment.

- record/playback amp board -

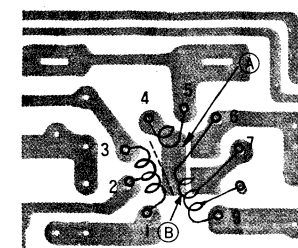
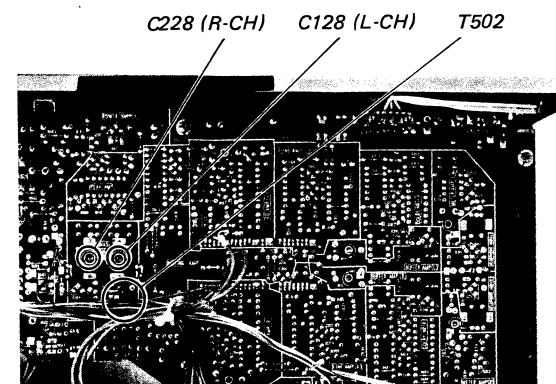

Record Level Adjustment

Procedure:

1. Mode: Standard record (See page 15.)

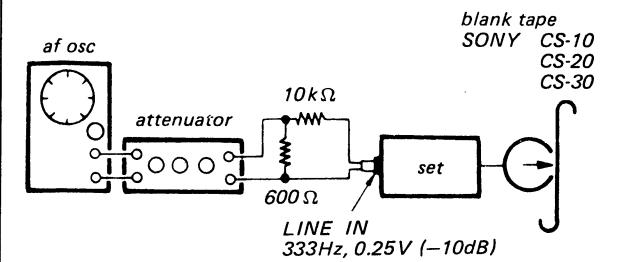

2. Mode: Playback

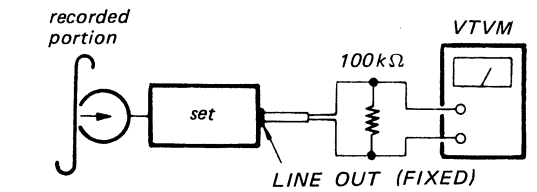

Adjust RV103 (L-CH) and RV203 (R-CH) to obtain the specified VTVM reading.

Specification:

| Tape | LINE OUT level |
|-------|----------------------------------|
| CS-10 | 0.41 - 0.46V (-5.5 to -4.5dB) |
| CS-20 | 0.37 - 0.52V |
| CS-30 | (-6.5 to -3.5dB) |

Adjustment Location:

- record/playback amp board -

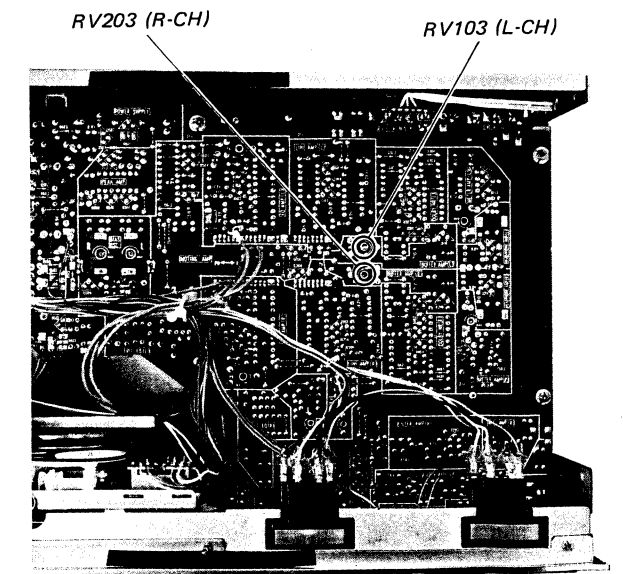

Record Bias Adjustment

Procedure:

1. Mode: Standard record (See page 15.)

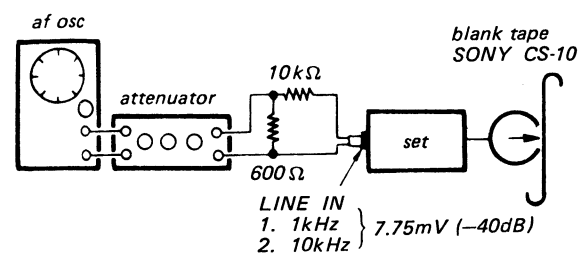

2. Mode: Playback

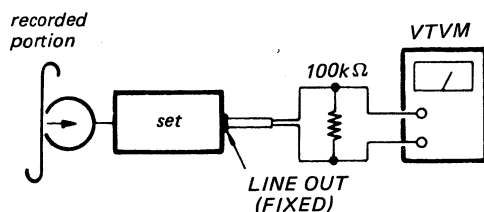

Adjust C128 (L-CH) and C228 (R-CH) to make 10kHz and 1kHz signal output levels equal.

Adjustment Location:

Note: Normally, patterns at **A** are bridged. If adjustment is not made with trimmers fully tightened, remove solder bridge at **A** and connect patterns at **B**, and repeat the adjustment.

— record/playback amp board —

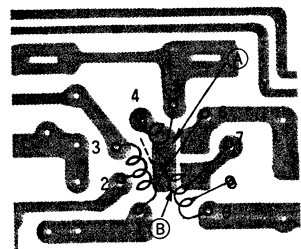
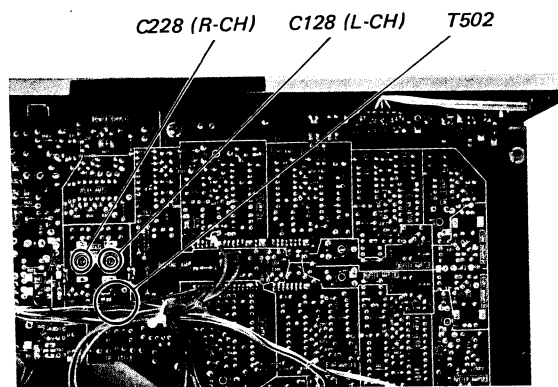

Record Level Adjustment

Procedure:

1. Mode: Standard record (See page 15.)

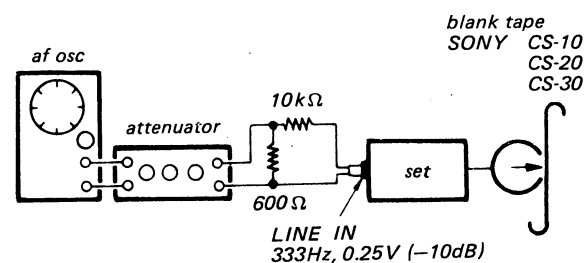

2. Mode: Playback

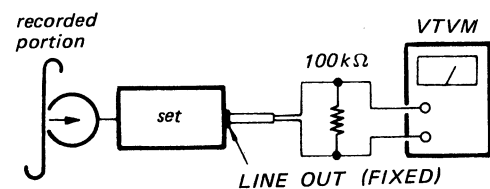

Adjust RV103 (L-CH) and RV203 (R-CH) to obtain the specified VTVM reading.

Specification:

| Tape | LINE OUT level |
|-------|----------------------------------|
| CS-10 | 0.41 - 0.46V (-5.5 to -4.5dB) |
| CS-20 | 0.37 - 0.52V |
| CS-30 | (-6.5 to -3.5dB) |

Adjustment Location:

— record/playback amp board —

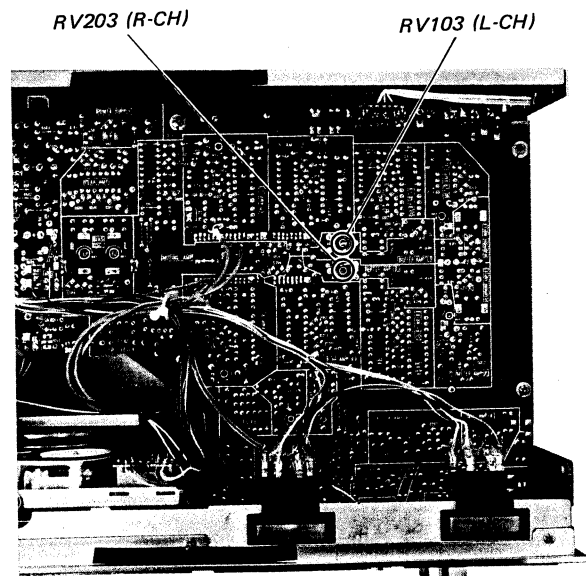

Level Meter Calibration

Procedure:

1. Mode: Standard record (See page 15.)

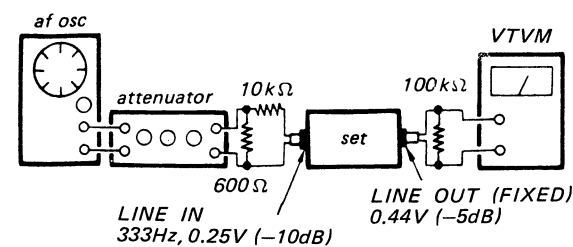

2.

| Adjust | Level meter reading: 0 VU |
|--------------|---------------------------|
| RV105 (L-CH) | |
| RV205 (R-CH) | |

Adjustment Location:

— record/playback amp board —

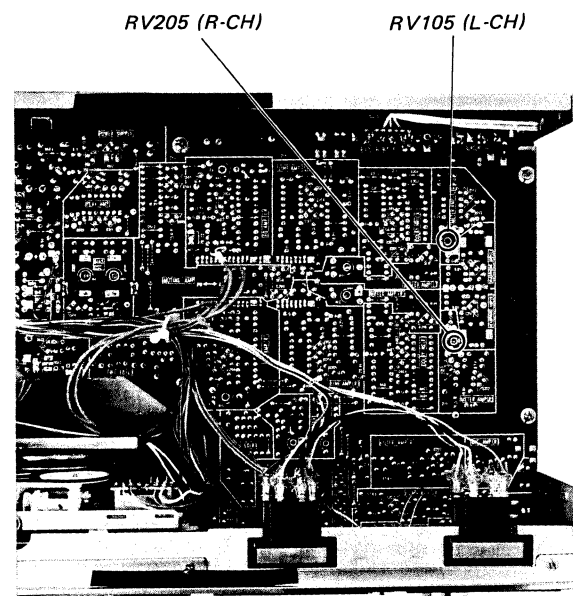

MPX Filter Adjustment

Procedure:

- Mode: Standard record (See page 15.)
DOLBY NR switch: ON (FILTER ON)

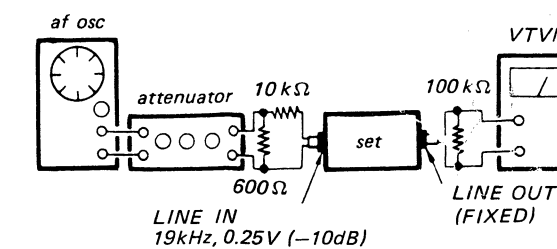

Adjust L102 (L-CH) and L202 (R-CH) for minimum VTVM reading.

Adjustment Location:

— record/playback amp board —

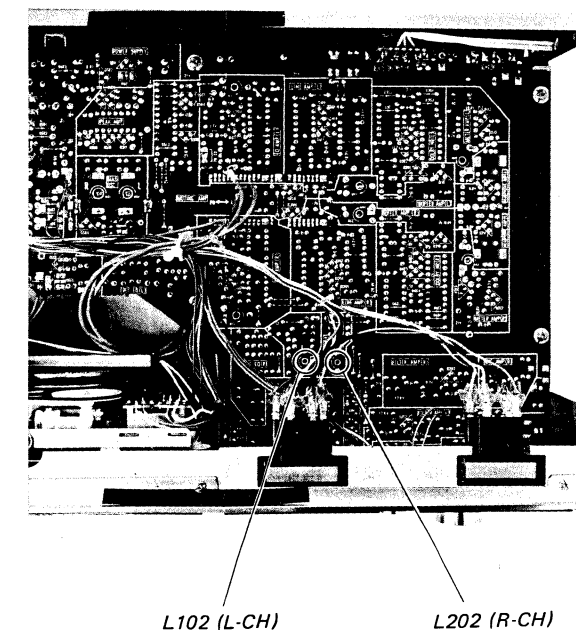

SECTION 4
DIAGRAMS

4-1. MOUNTING DIAGRAMS

— Conductor Side —

Replacement semiconductors

For replacement, use semiconductors except in ().

Q101-104, 107, 110
Q201-204, 207, 210

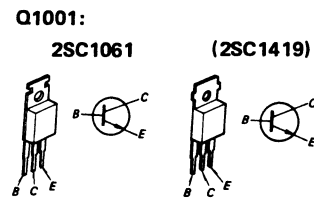
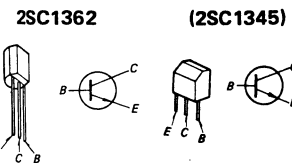

Q108, 109, 208, 209:

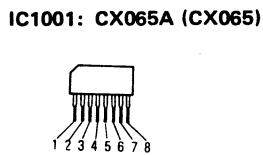
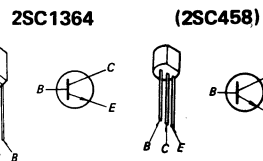

IC1001: CX065A (CX065)

D301, 303, 304
D401, 403, 404 } : 1S1555 (1S2076)
D513

D302, 402 : 1T22AM (1T22)

D501, 502, 506, 507 } : 10E2
D511, 512

Q106, 111-113
Q206, 211-213
Q301-304,
Q401-404
Q502-505, 507-512

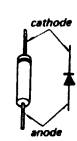
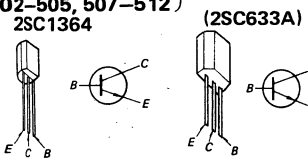

D503: EQB01-07 (EQB01-07R)

Q501, 513:

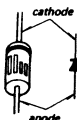
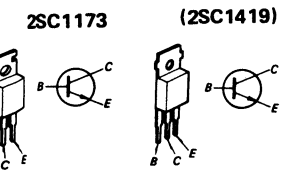

(AEP, E, UK MODEL)

Q506: 2SC1475 (2SC1318)

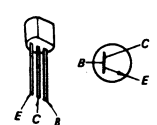

D514: 1S2076A (1S2076)

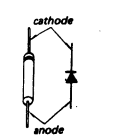

D508-510: SLP-24B

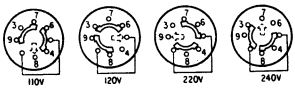
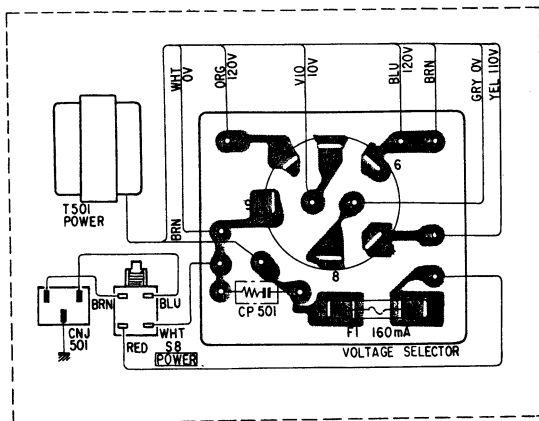
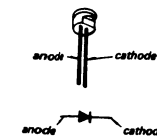

| D | Q, IC |
|-----|---------------|
| 503 | 501 |
| 304 | 503 |
| 302 | 507, 508 |
| 303 | 504 |
| 301 | 109 |
| | 112 |
| 501 | 104 |
| | 108 |
| 505 | 103 |
| 502 | 505, 107 |
| 514 | 509, 510, 511 |
| | 303 |
| 513 | 302 |
| | 110 |
| | 301 |
| | 111 |
| | 106 |
| | 113 |
| 512 | 206 |
| 507 | |
| 506 | 506 |
| | 211 |
| | 210 |
| | 401 |
| 508 | 512 |
| | 203 |
| | 207 |
| 511 | 208 |
| | 403 |
| 509 | 209 |
| | 404 |
| | 213 |
| 510 | 401 |
| | 403 |
| | 404 |
| | 402 |
| | 202 |
| | 201 |
| | 101 |
| | 102 |
| | IC1001 |
| D | Q, IC |

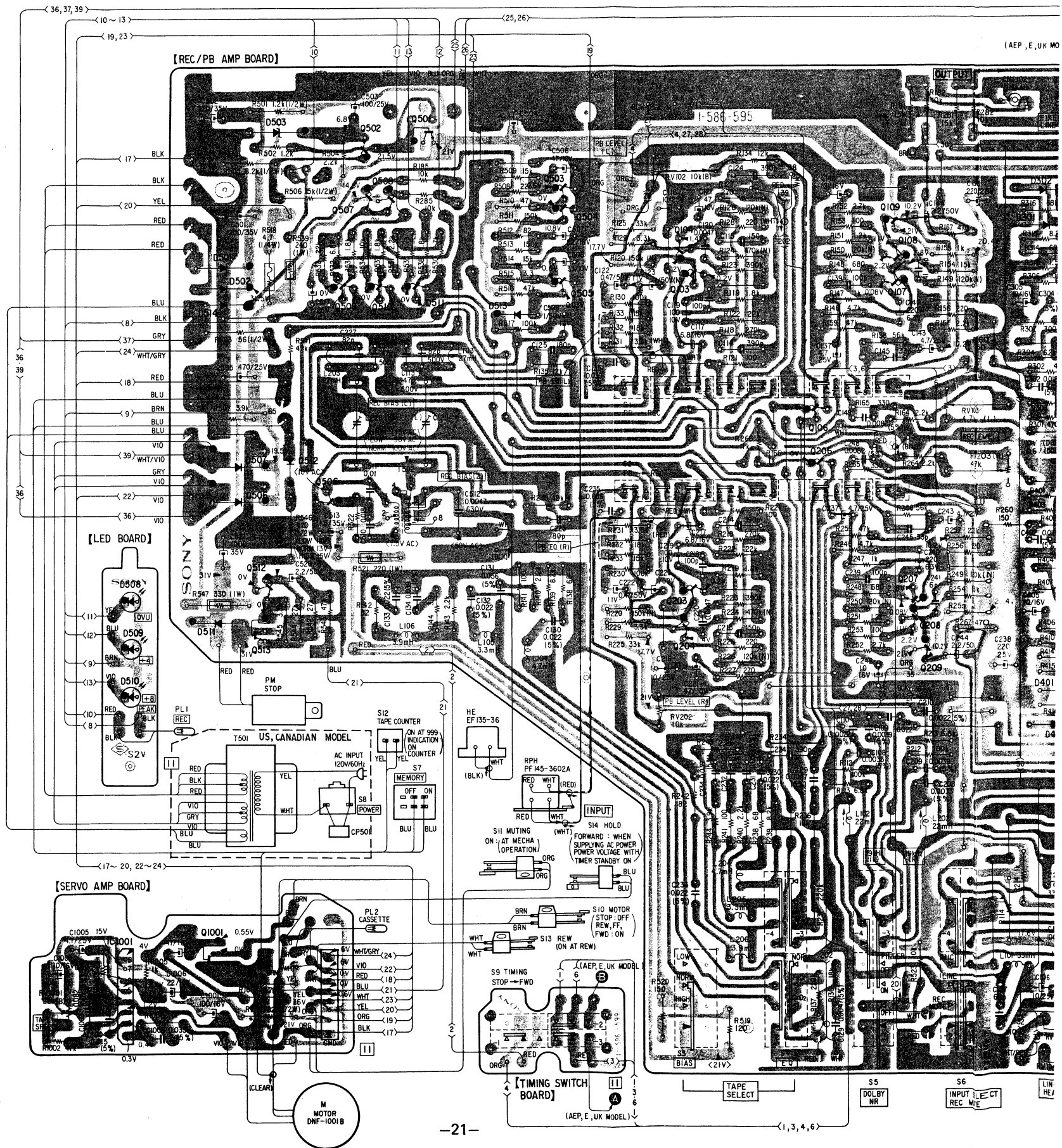

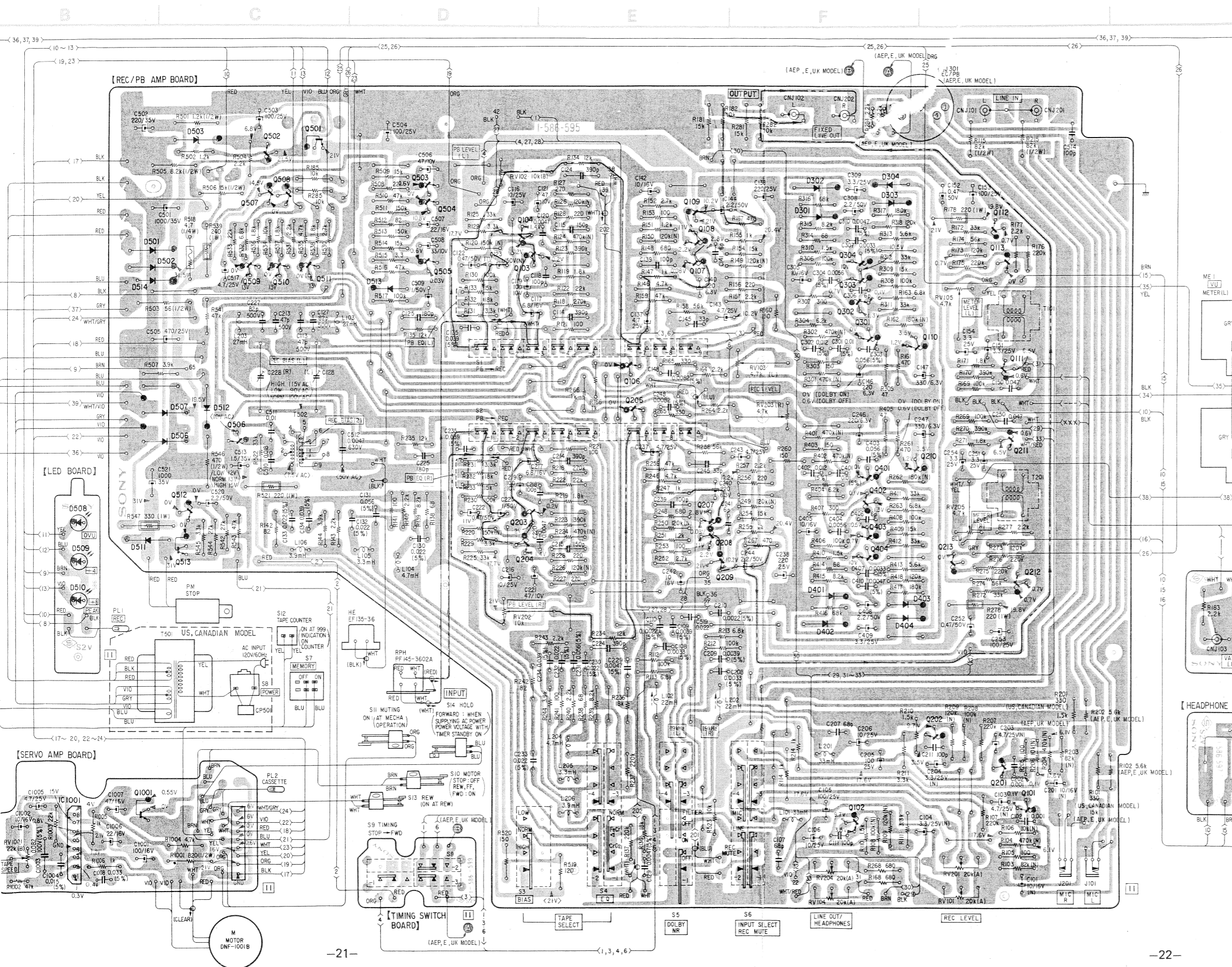

• Color code of sleeving over the end of the jacket.

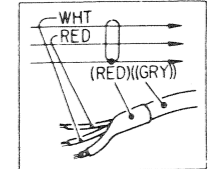

• B+ pattern.
• Signal path — L-CH
— R-CH

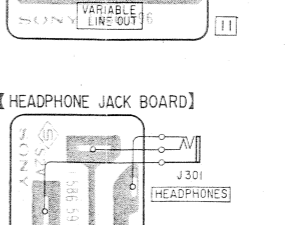
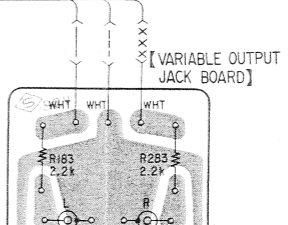
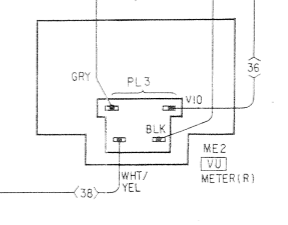
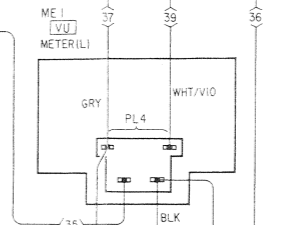

4-2. SCHEMATIC DIAGRAM

TC-K5 TC-K5

Note: The components identified by shading and mark  are critical for safety. Replace only with part number specified.

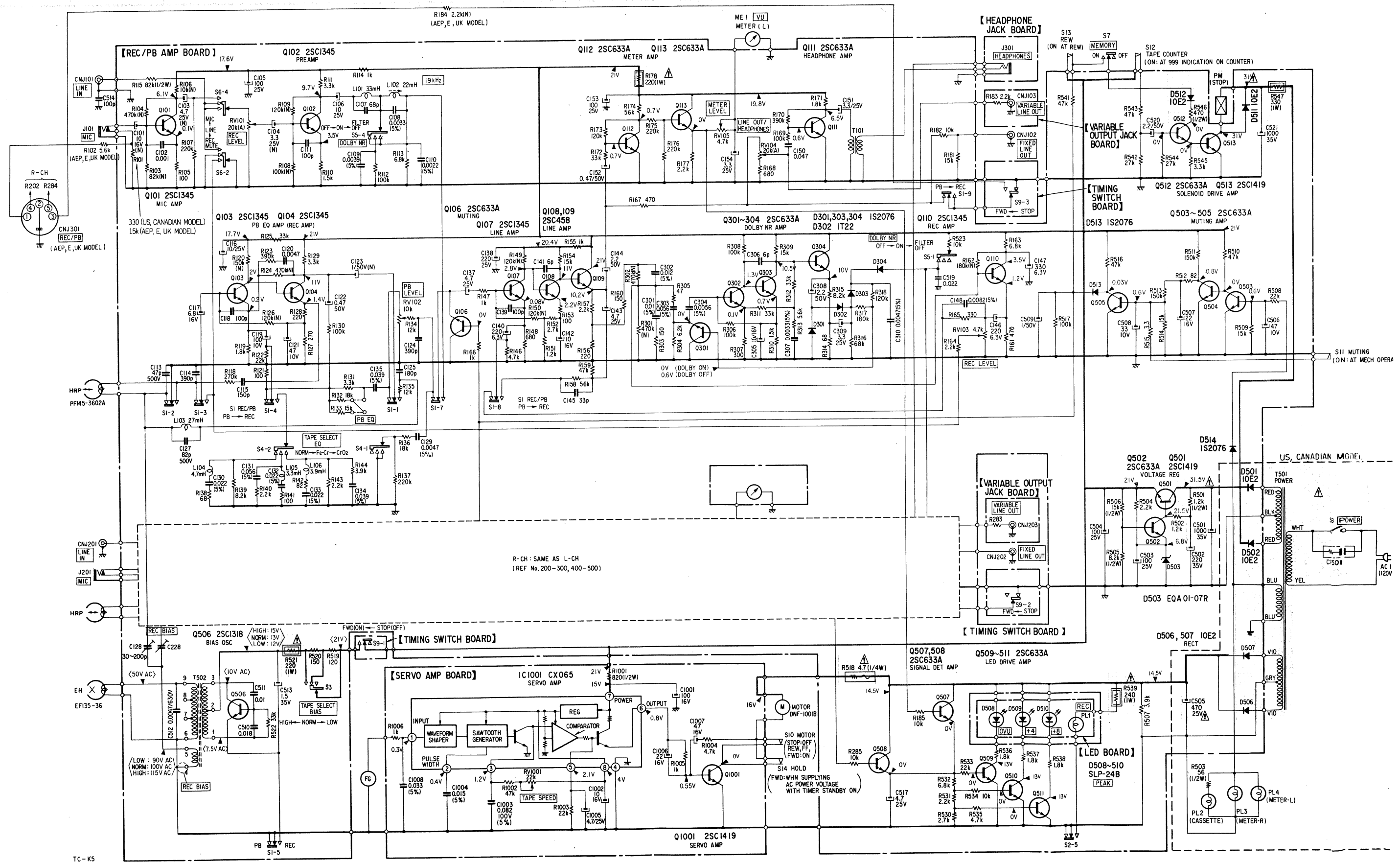

TC-K5

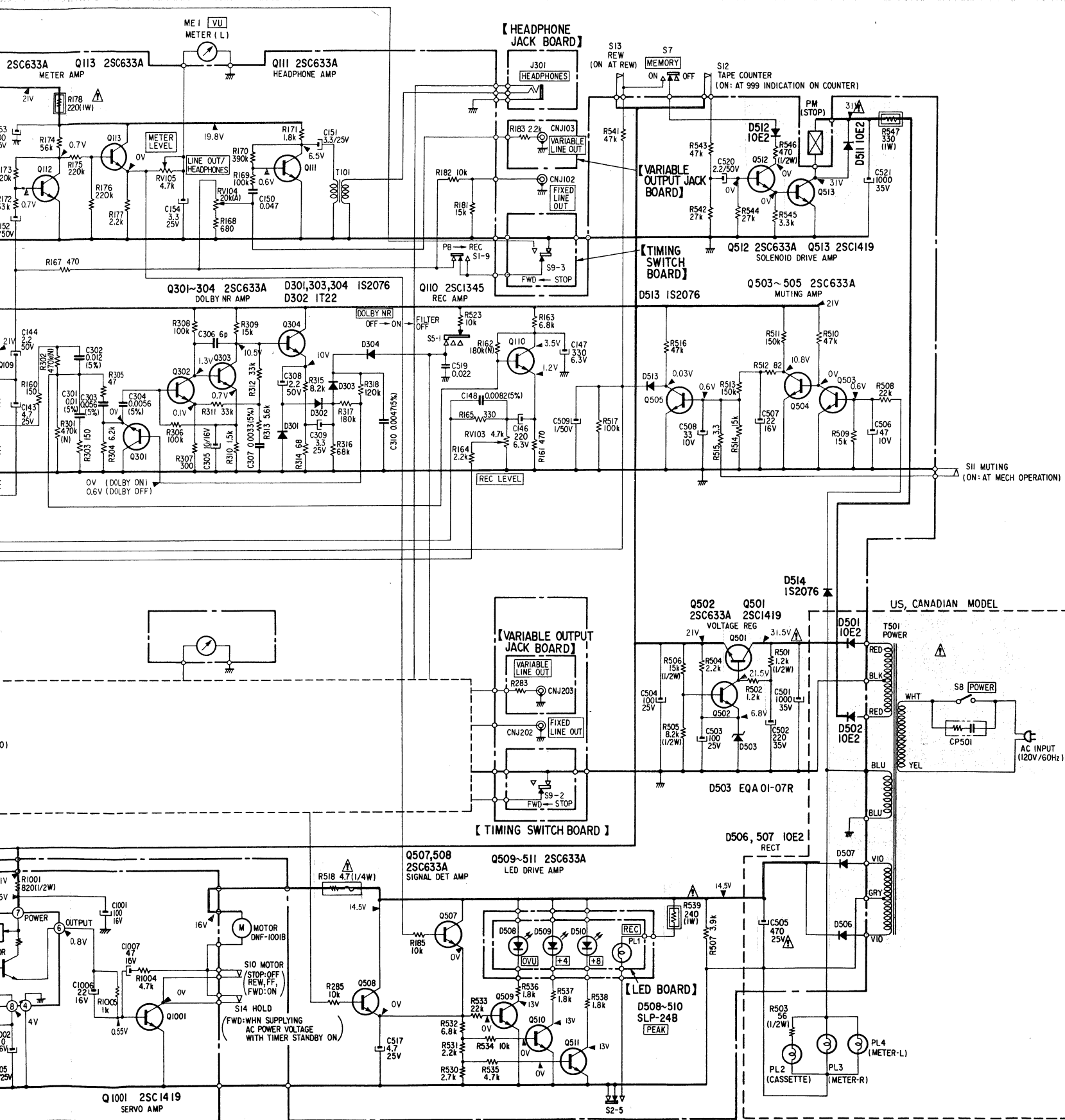

Note: Les composants identifiés par un tramé et une marque sont critiques pour la sécurité. Ne les remplacer que par une pièce portant le numéro spécifié.

- Note:**
- Components for right channel have the same values as for left channel. Reference numbers are coded from 201 or 401.
 - All capacitors are in μF unless otherwise noted. $\text{pF} = \mu\mu\text{F}$ 50WV or less are not indicated except for electrolytics.
 - All resistors are in ohms, $\frac{1}{2}\text{W}$ unless otherwise noted. $\text{k}\Omega = 1000\Omega$, $\text{M}\Omega = 1000\text{k}\Omega$
 - : nonflammable resistor.
 - : fusible resistor.
 - (N): low-noise capacitor and resistor.
 - 5% indicates component tolerance.
 - : B+ bus.
 - : panel designation.
 - : adjustment for repair.
 - Voltages are dc with respect to ground unless otherwise noted.
 - Readings are taken under no-signal conditions with a VOM (20k Ω /V).
 - < > : record mode
 - AC voltage readings in the bias oscillator circuit are taken with a VTVM.
 - Voltage variations may be noted due to normal production tolerances.
 - Switch

| Ref. No. | Switch | Position |
|----------|---------------|----------|
| S1 | REC/PB (L-CH) | PB |
| S2 | REC/PB (R-CH) | PB |
| S3 | BIAS | NORMAL |
| S4 | EQ | NORMAL |
| S5 | DOLBY NR | OFF |
| S6 | INPUT SELECT | LINE |
| S7 | MEMORY | OFF |
| S8 | POWER | OFF |
| S9 | TIMING | STOP |
| S10 | MOTOR | OFF |
| S11 | MUTING | OFF |
| S12 | TAPE COUNTER | OFF |
| S13 | REW | OFF |
| S14 | HOLD | OFF |

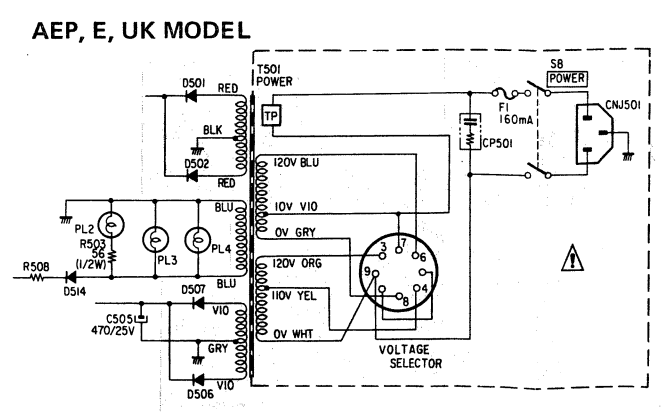

SECTION 5
EXPLODED VIEWS

5-1.

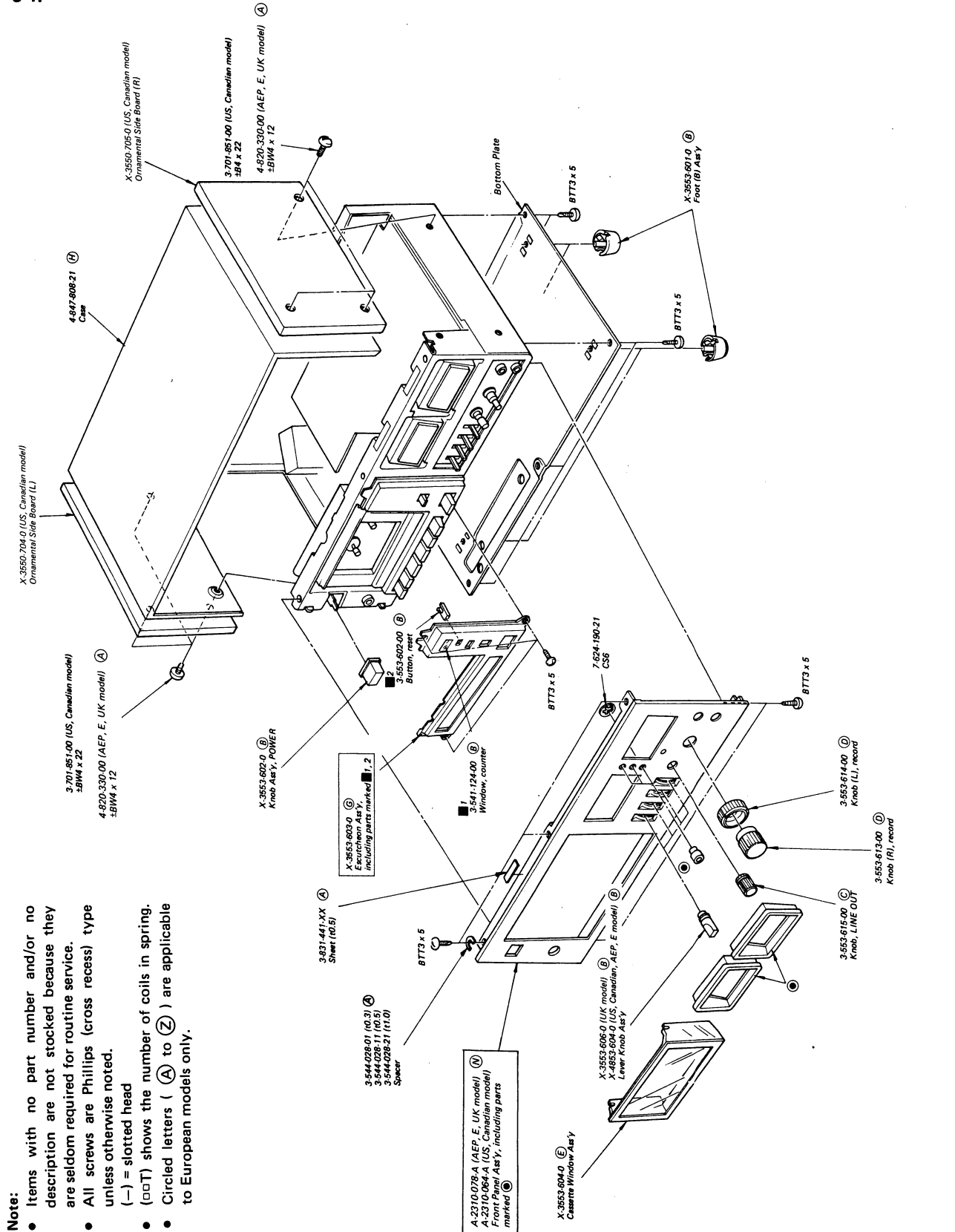

- Note:**
- Items with no part number and/or no description are not stocked because they are seldom required for routine service.
 - All screws are Phillips (cross recess) type unless otherwise noted.
 - (□□□) shows the number of coils in spring.
 - Circled letters (A) to (Z) are applicable to European models only.

5-2.

Note: The components identified by shading and mark **▲** are critical for safety. Replace only with part number specified.

Note: Les composants identifiés par un tramage et une marque **▲** sont critiques pour la sécurité. Ne les remplacer que par une pièce portant le numéro spécifié.

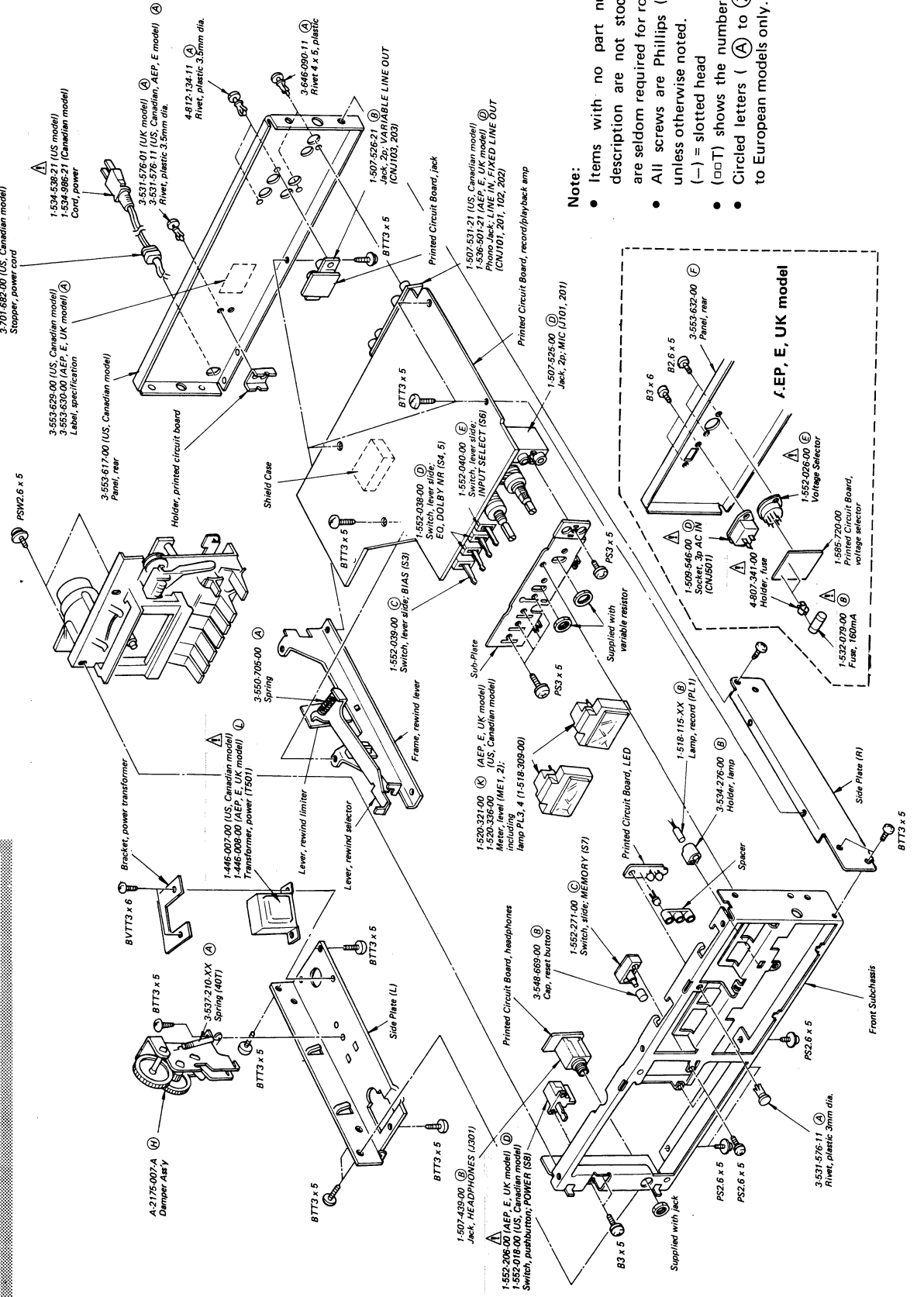

- Note:**
- Items with no part number and/or no description are not stocked because they are seldom required for routine service.
 - All screws are Phillips (cross recess) type unless otherwise noted.
 - (□□□) shows the number of coils in spring.
 - Circled letters (A) to (Z) are applicable to European models only.

5-4.

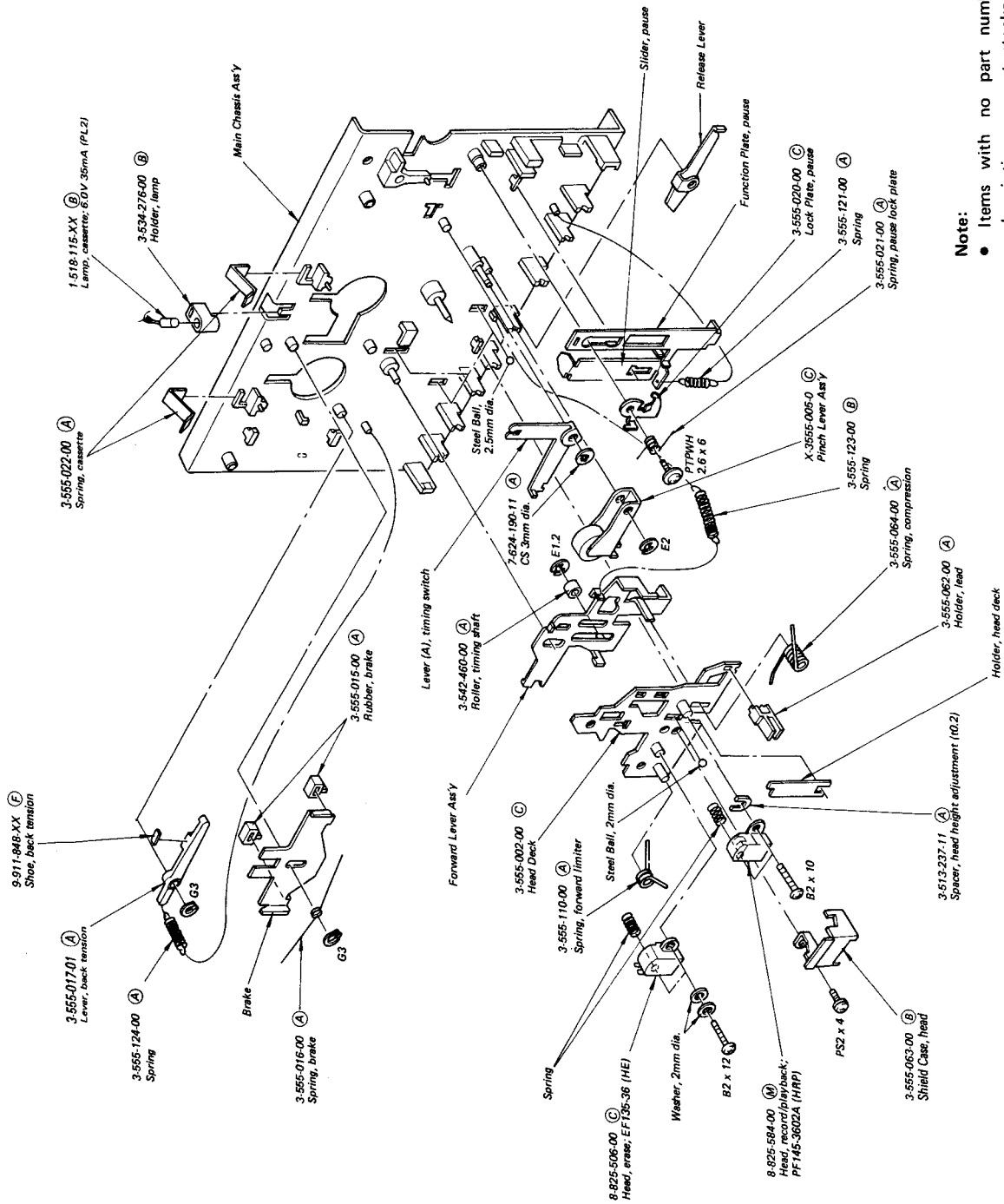

Note:

- Items with no part number and/or no description are not stocked because they are seldom required for routine service.
- All screws are Phillips (cross recess) type unless otherwise noted.
- (—) = slotted head
- (□□T) shows the number of coils in spring.
- Circled letters (A) to (Z) are applicable to European models only.

5-5.

A B C D E

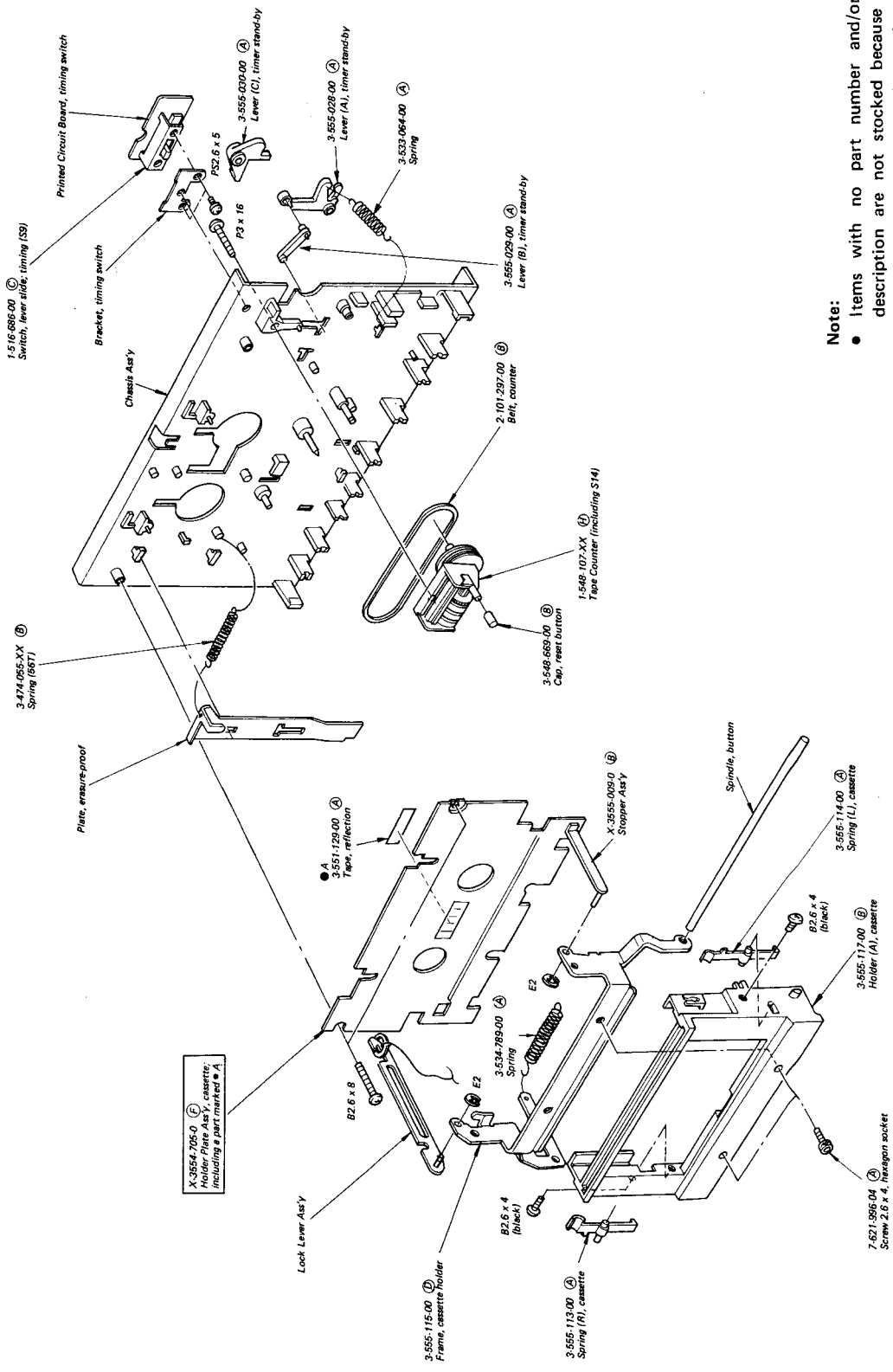

Note:

- Items with no part number and/or no description are not stocked because they are seldom required for routine service.
- All screws are Phillips (cross recess) type unless otherwise noted.
- (□□T) shows the number of coils in spring.
- Circled letters (A to Z) are applicable to European models only.

SECTION 6 ELECTRICAL PARTS LIST

Ref. No. Part No. Description

CIRCUIT BOARDS

1-585-720-00 Voltage Selector

SEMICONDUCTORS

Transistors

⇒ Q101-104 } 8-729-665-47 (B) 2SC1362
 ⇒ Q201-204 }
 ⇒ Q106, 206 } 8-729-663-47 (B) 2SC1364
 ⇒ Q107, 207 } 8-729-665-47 (B) 2SC1362
 ⇒ Q108, 208 } 8-729-663-47 (B) 2SC1364
 ⇒ Q109, 209 }
 ⇒ Q110, 210 } 8-729-665-47 (B) 2SC1362
 ⇒ Q111-113 } 8-729-663-47 (B) 2SC1364
 ⇒ Q211-213 }

 ⇒ Q301-304 } 8-729-663-47 (B) 2SC1364
 ⇒ Q401-404 }

 ⇒ Q501 ⚠ 8-729-217-33 (C) 2SC1173
 ⇒ Q502-505 } 8-729-663-47 (B) 2SC1364
 ⇒ Q506 8-760-413-10 (B) 2SC1475
 ⇒ Q507-512 } 8-729-663-47 (B) 2SC1364
 ⇒ Q513 ⚠ 8-729-217-33 (C) 2SC1173
 Q1001 8-729-316-12 (C) 2SC1061

Diodes

⇒ D301, 401 } 8-719-815-55 (A) 1S1555
 ⇒ D302, 402 } 8-719-422-21 (A) 1T22AM
 ⇒ D303, 403 } 8-719-815-55 (A) 1S1555
 ⇒ D304, 404 }
 D501, 502 } ⚠ 8-719-200-02 (B) 10E2
 ⇒ D503 8-719-931-07 (B) EQB01-07
 D506, 507 } ⚠ 8-719-200-02 (B) 10E2
 D508-510 } 8-719-900-24 (B) SLP-24B
 D511, 512 } ⚠ 8-719-200-02 (B) 10E2
 D513 8-719-815-55 (A) 1S1555
 D514 8-719-923-76 (A) 1S2076A

IC

IC1001 8-759-600-65 (D) CX065A

Note:

- ⇒: Due to standardization, interchangeable replacements may be substituted for parts specified in the diagrams.

Note: The components identified by shading and mark ⚠ are critical for safety. Replace only with part number specified.

Ref. No. Part No. Description

COILS

All coils are microinductors unless otherwise noted.

L101, 201 1-407-212-XX (B) 33mH
 L102, 202 1-407-240-00 (B) 22mH, variable; 19kHz
 L103, 203 1-407-211-XX (B) 27mH
 L104, 204 1-407-202-XX (B) 4.7mH
 L105, 205 1-407-200-XX (B) 3.3mH
 L106, 206 1-407-201-XX (B) 3.9mH

TRANSFORMERS

T101, 201 1-427-424-00 (C) Output
 T501 ⚠ 1-446-007-00 Power (US, Canadian model)
 ⚠ 1-446-008-00 (L) Power (AEP, E, UK model)
 T502 1-433-132-00 (C) Oscillator

CAPACITORS

All capacitors are in μF and ceramic unless otherwise noted. 50WV or less working voltages are not indicated except for electrolytics. pF : $\mu\mu\text{F}$, elect : electrolytic

C101, 201 1-121-916-11 (B) 10 16V elect
 C102, 202 1-102-074-11 (A) 0.001
 C103, 203 1-121-915-11 (A) 4.7 25V elect
 C104, 204 1-121-913-11 (A) 3.3 25V elect
 C105, 205 1-121-416-11 (B) 100 25V elect

 C106, 206 1-121-398-11 (A) 10 25V elect
 C107, 207 1-101-888-11 (A) 68p
 C108, 208 1-108-567-12 (A) 0.0033 mylar
 C109, 209 1-108-569-12 (B) 0.0039 mylar
 C110, 210 1-108-563-12 (B) 0.0022 mylar

 C111, 211 1-102-106-11 (A) 100p
 C113, 213 1-107-163-11 (A) 47p 500V mica
 C114, 214 1-102-113-11 (A) 390p
 C115, 215 1-102-108-11 (A) 150p

 C116, 216 1-121-398-11 (A) 10 25V elect
 C117, 217 1-131-198-11 (B) 6.8 16V tantalum
 C118, 218 1-102-106-11 (A) 100p
 C119, 219 1-121-414-11 (A) 100 10V elect
 C120, 220 1-108-571-12 (A) 0.0047 mylar

- Circled letters (A) to (Z) are applicable to European models only.

Note: Les composants identifiés par un tramé et une marque ⚠ sont critiques pour la sécurité. Ne les remplacer que par une pièce portant le numéro spécifié.

• Circled letters (**A** to **Z**) are applicable to European models only.

| <u>Ref. No.</u> | <u>Part No.</u> | <u>Description</u> | | |
|-----------------|-----------------|--------------------|------|---------|
| C121, 221 | 1-121-352-11 | A 47 | 10V | elect |
| C122, 222 | 1-121-726-11 | A 0.47 | 50V | elect |
| C123, 223 | 1-121-912-11 | A 1 | 50V | elect |
| C124, 224 | 1-102-113-11 | A 390p | | |
| C125, 225 | 1-102-109-11 | A 180p | | |
| C127, 227 | 1-107-037-11 | A 82p | 500V | mica |
| C128, 228 | 1-141-010-XX | B | | trimmer |
| C129, 229 | 1-108-571-12 | A 0.0047 | | mylar |
| C130, 230 | 1-108-587-12 | A 0.022 | | mylar |
| C131, 231 | 1-108-597-12 | B 0.056 | | mylar |
| C132, 232 | 1-108-587-12 | A 0.022 | | mylar |
| C133, 233 | 1-108-587-12 | A 0.022 | | mylar |
| C134, 234 | 1-108-593-12 | B 0.039 | | mylar |
| C135, 235 | 1-108-593-12 | B 0.039 | | mylar |
| C137, 237 | 1-121-395-11 | A 4.7 | 25V | elect |
| C138, 238 | 1-121-422-11 | B 220 | 25V | elect |
| C139, 239 | 1-102-106-11 | A 100p | | |
| C140, 240 | 1-121-419-11 | B 220 | 6.3V | elect |
| C141, 241 | 1-102-943-11 | A 6p | | |
| C142, 242 | 1-121-651-11 | A 10 | 16V | elect |
| C143, 243 | 1-121-395-11 | A 4.7 | 25V | elect |
| C144, 244 | 1-121-450-11 | A 2.2 | 50V | elect |
| C145, 245 | 1-102-963-11 | A 33p | | |
| C146, 246 | 1-121-419-11 | B 220 | 6.3V | elect |
| C147, 247 | 1-121-751-11 | B 330 | 6.3V | elect |
| C148, 248 | 1-108-577-12 | A 0.0082 | | mylar |
| C150, 250 | 1-108-246-12 | A 0.047 | | mylar |
| C151, 251 | 1-121-392-11 | A 3.3 | 25V | elect |
| C152, 252 | 1-121-726-11 | A 0.47 | 50V | elect |
| C153, 253 | 1-121-416-11 | B 100 | 25V | elect |
| C154, 254 | 1-121-392-11 | A 3.3 | 25V | elect |
| C301, 401 | 1-108-579-12 | A 0.01 | | mylar |
| C302, 402 | 1-108-581-12 | B 0.012 | | mylar |
| C303, 403 | 1-108-597-12 | B 0.056 | | mylar |
| C304, 404 | 1-108-573-12 | A 0.0056 | | mylar |
| C305, 405 | 1-121-651-11 | A 10 | 16V | elect |
| C306, 406 | 1-102-943-11 | A 6p | | |
| C307, 407 | 1-108-567-12 | A 0.0033 | | mylar |
| C308, 408 | 1-121-986-11 | A 2.2 | 50V | elect |

| <u>Ref. No.</u> | <u>Part No.</u> | <u>Description</u> | | |
|-----------------|-----------------------|--------------------|------|------------------|
| C309, 409 | 1-121-960-11 | A 3.3 | 25V | elect |
| C310, 410 | 1-108-571-12 | A 0.0047 | | mylar |
| C501 | A 1-121-945-11 | C 1000 | 35V | elect |
| C502 | 1-121-261-11 | B 220 | 35V | elect |
| C503, 504 | 1-121-416-11 | B 100 | 25V | elect |
| C505 | A 1-121-939-11 | B 470 | 16V | elect |
| C506 | 1-121-975-11 | A 47 | 10V | elect |
| C507 | 1-121-990-11 | A 22 | 16V | elect |
| C508 | 1-121-974-11 | B 33 | 10V | elect |
| C509 | 1-121-391-11 | A 1 | 50V | elect |
| C510 | 1-108-585-12 | B 0.018 | | mylar |
| C511 | 1-108-579-12 | B 0.01 | | mylar |
| C512 | 1-129-710-11 | A 0.0047 | 630V | film |
| C513 | 1-131-216-11 | B 1.5 | 35V | tantalum |
| C514 | 1-102-106-11 | A 100p | | |
| C517 | 1-121-395-11 | A 4.7 | 25V | elect |
| C519 | 1-161-034-11 | A 0.022 | | (boundary layer) |
| C520 | 1-121-986-11 | A 2.2 | 50V | elect |
| C521 | 1-121-388-11 | C 1000 | 35V | elect |
| C1001 | 1-121-415-11 | A 100 | 16V | elect |
| C1002 | 1-121-651-11 | A 10 | 16V | elect |
| C1003 | 1-130-134-11 | B 0.0082 | 100V | film |
| C1004 | 1-108-583-11 | A 0.015 | | mylar |
| C1005 | 1-121-395-11 | A 4.7 | 25V | elect |
| C1006 | 1-121-479-11 | A 22 | 16V | elect |
| C1007 | 1-121-409-11 | A 47 | 16V | elect |
| C1008 | 1-108-591-11 | A 0.033 | | mylar |

RESISTORS

All resistors are in ohms. Common 1/4W carbon resistors are omitted. Refer to the list on page 36 for their part numbers.

All adjustable and variable resistors have characteristic curve B, unless otherwise noted. kΩ : 1000Ω, MΩ : 1000kΩ

| | | | | |
|-----------|-----------------------|---------------|------|-------------------------------|
| R115, 215 | 1-244-919-11 | A 82k | 1/2W | carbon |
| R178, 278 | A 1-213-135-11 | A 220 | 1W | metal oxide (nonflammable) |
| R501 | A 1-244-875-11 | A 1.2k | 1/2W | carbon |
| R503 | 1-244-843-11 | A 56 | 1/2W | carbon |

Note: The components identified by shading and mark **A** are critical for safety. Replace only with part number specified.

Note: Les composants identifiés par un tramé et une marque **A** sont critiques pour la sécurité. Ne les remplacer que par une pièce portant le numéro spécifié.

• Circled letters (**A** to **Z**) are applicable to European models only.

| <u>Ref. No.</u> | <u>Part No.</u> | <u>Description</u> | | |
|-----------------|-----------------------|-----------------------------|-------------|-------------------------------|
| R505 | 1-244-895-11 | A 8.2k | ½W | carbon |
| R506 | 1-244-901-11 | A 15k | ½W | carbon |
| R518 | A 1-217-383-11 | B 4.7 | ½W | fusible |
| R521 | A 1-213-135-11 | A 220 | 1W | metal oxide (nonflammable) |
| R539 | A 1-213-262-11 | A 240 | 1W | metal oxide (nonflammable) |
| R546 | A 1-244-865-11 | A 470 | ½W | carbon |
| R547 | A 1-213-137-11 | A 330 | 1W | metal oxide (nonflammable) |
| R1001 | 1-244-871-11 | A 820 | ½W | carbon |
| RV101,201 | 1-224-907-00 | B 20k (A), variable; | REC LEVEL | |
| RV102,202 | 1-224-645-XX | B 20k, variable; | REC LEVEL | |
| RV103,203 | 1-224-644-XX | B 10k, adjustable; | PB LEVEL | |
| RV104,204 | 1-224-906-00 | D 4.7k, variable; | REC LEVEL | |
| RV105,205 | 1-224-644-XX | B 4.7k, adjustable; | METER LEVEL | |
| RV1001 | 1-224-491-00 | B 22k, adjustable; | TAPE SPEED | |

SWITCHES

| | | |
|-------|-----------------------|-----------------------------------------------|
| S1, 2 | 1-552-204-00 | F Slide, REC/PB |
| S3 | 1-552-039-00 | C Lever Slide, BIAS |
| S4 | 1-552-038-00 | D Lever Slide, EQ |
| S5 | 1-552-038-00 | D Lever Slide, DOLBY NR |
| S6 | 1-552-040-00 | E Lever Slide, INPUT SELECT |
| S7 | 1-552-271-00 | C Slide, MEMORY |
| S8 | A 1-552-018-00 | Pushbutton, POWER (US, Canadian model) |
| | A 1-552-206-11 | D Pushbutton, POWER (AEP, E, UK model) |
| S9 | 1-516-686-00 | C Lever Slide, timing |
| S10 | 1-516-853-XX | C Leaf, motor on/off |
| S11 | 1-516-853-XX | C Leaf, muting |
| S13 | 1-516-853-XX | C Leaf, REW |
| S14 | 1-514-912-00 | B Leaf, HOLD |

CONNECTORS

| | | |
|-----------|--------------|---------------------------|
| J101, 201 | 1-507-525-00 | D Jack, 2p; MIC |
| J301 | 1-507-439-00 | B Jack, HEADPHONES |

| <u>Ref. No.</u> | <u>Part No.</u> | <u>Description</u> |
|-----------------|-----------------------|------------------------------------------------------------------------|
| CNJ101,201 | 1-507-531-21 | Phono Jack, 4p; LINE IN, FIXED LINE OUT (US, Canadian model) |
| CNJ102,202 | | |
| CNJ101,201 | 1-536-501-21 | D Phono Jack, 4p; LINE IN, FIXED LINE OUT (AEP, E, UK model) |
| CNJ301 | | |
| CNJ102,202 | | |
| CNJ103,203 | 1-507-526-21 | B Phono Jack, 2p; VARIABLE LINE OUT |
| CNJ501 | A 1-509-546-00 | D Socket, 3p AC IN (AEP, E, UK model) |

MISCELLANEOUS

| | | |
|--------|-----------------------|------------------------------------------------|
| CP501 | A 1-231-057-31 | B Spark Killer (AEP, E, UK model) |
| | A 1-231-341-21 | Spark Killer (Canadian model) |
| | A 1-231-326-11 | Spark Killer (US model) |
| EH | 8-825-506-00 | C Head, erase; EF135-36 |
| F1 | A 1-532-079-00 | B Fuse, 160mA (AEP, E, UK model) |
| M | 8-835-006-00 | L Motor, DNF-1001B |
| ME1, 2 | 1-520-321-00 | K Meter, level (AEP, E, UK model) |
| | 1-520-336-00 | Meter, level (US, Canadian model) |
| PL1 | 1-518-115-XX | B Lamp, REC 6.0V, 35mA |
| PL2 | 1-518-115-XX | B Lamp, cassette; 6.0V, 35mA |
| PL3, 4 | 1-518-309-00 | B Lamp, meter |
| PM | A 1-454-123-00 | F Solenoid, STOP |
| RPB | 8-825-584-00 | M Head, record/playback; PF145-3602A |
| | 1-507-531-21 | Plate, jack (US, Canadian model) |
| | A 1-534-538-21 | Cord, power (US model) |
| | A 1-534-986-XX | Cord, power (Canadian model) |
| | 1-548-107-XX | H Tape Counter (including S14) |
| | A 1-552-026-00 | E Voltage Selector (AEP, E, UK model) |

Note: Les composants identifiés par un tramé et une marque **A** sont critiques pour la sécurité. Ne les remplacer que par une pièce portant le numéro spécifié.

Note: The components identified by shading and mark **A** are critical for safety. Replace only with part number specified.

Note: The components identified by shading and mark **⚠** are critical for safety. Replace only with part number specified.

Note: Les composants identifiés par un tramé et une marque **⚠** sont critiques pour la sécurité. Ne les remplacer que par une pièce portant le numéro spécifié.

ACCESSORIES AND PACKING MATERIALS

| <i>Part No.</i> | <i>Description</i> |
|-----------------------|--------------------------------------------|
| X-3553-607-0 | (A) Cushion Ass'y, (AEP, E, UK model) |
| X-3701-105-0 | (A) Tips Ass'y, head cleaning |
| 1-534-049-31 | (D) Cord, connecting; RK-74H |
| ⚠ 1-534-754-14 | Cord, power; parallel-blade plug (E model) |
| ⚠ 1-551-216-11 | Cord, power; euro-plug (E model) |
| ⚠ 1-534-819-00 | (G) Cord, power (UK model) |
| 3-429-126-00 | Bag, plastic (Canadian model) |
| 3-550-733-00 | (B) Spacer (AEP model) |
| 3-550-734-00 | Holder, cord (E model) |
| 3-550-739-00 | Cushion A (US, Canadian model) |
| 3-550-740-00 | Cushion B (US, Canadian model) |
| 3-553-636-00 | Carton (US, Canadian model) |
| 3-553-637-00 | (E) Carton (AEP, UK model) |
| 3-553-639-00 | Carton (E model) |
| 3-770-364-11 | (F) Manual, instruction (AEP, E, UK model) |
| 3-770-364-31 | Manual, instruction (US, Canadian model) |
| 3-794-173-31 | Leaflet, instruction (Canadian model) |
| 4-818-924-00 | (B) Bag, plastic (E, UK model) |
| 3-553-640-00 | (B) Spacer (UK model) |

• Circled letters (A) to (Z) are applicable to European models only.

1/4 WATT CARBON RESISTORS (A)

| Ω | Part No. | Ω | Part No. | Ω | Part No. | Ω | Part No. | Ω | Part No. | Ω | Part No. | Ω | Part No. |
|-----|--------------|----|--------------|-----|--------------|------|--------------|-----|--------------|------|--------------|------|--------------|
| 1.0 | 1-244-601-11 | 10 | 1-244-625-11 | 100 | 1-244-649-11 | 1.0k | 1-244-673-11 | 10k | 1-244-697-11 | 100k | 1-244-721-11 | 1.0M | 1-244-745-11 |
| 1.1 | 1-244-602-11 | 11 | 1-244-626-11 | 110 | 1-244-650-11 | 1.1k | 1-244-674-11 | 11k | 1-244-698-11 | 110k | 1-244-722-11 | 1.1M | 1-244-746-11 |
| 1.2 | 1-244-603-11 | 12 | 1-244-627-11 | 120 | 1-244-651-11 | 1.2k | 1-244-675-11 | 12k | 1-244-699-11 | 120k | 1-244-723-11 | 1.2M | 1-244-747-11 |
| 1.3 | 1-244-604-11 | 13 | 1-244-628-11 | 130 | 1-244-652-11 | 1.3k | 1-244-676-11 | 13k | 1-244-700-11 | 130k | 1-244-724-11 | 1.3M | 1-244-748-11 |
| 1.5 | 1-244-605-11 | 15 | 1-244-629-11 | 150 | 1-244-653-11 | 1.5k | 1-244-677-11 | 15k | 1-244-701-11 | 150k | 1-244-725-11 | 1.5M | 1-244-749-11 |
| 1.6 | 1-244-606-11 | 16 | 1-244-630-11 | 160 | 1-244-654-11 | 1.6k | 1-244-678-11 | 16k | 1-244-702-11 | 160k | 1-244-726-11 | 1.6M | 1-244-750-11 |
| 1.8 | 1-244-607-11 | 18 | 1-244-631-11 | 180 | 1-244-655-11 | 1.8k | 1-244-679-11 | 18k | 1-244-703-11 | 180k | 1-244-727-11 | 1.8M | 1-244-751-11 |
| 2.0 | 1-244-608-11 | 20 | 1-244-632-11 | 200 | 1-244-656-11 | 2.0k | 1-244-680-11 | 20k | 1-244-704-11 | 200k | 1-244-728-11 | 2.0M | 1-244-752-11 |
| 2.2 | 1-244-609-11 | 22 | 1-244-633-11 | 220 | 1-244-657-11 | 2.2k | 1-244-681-11 | 22k | 1-244-705-11 | 220k | 1-244-729-11 | 2.2M | 1-244-753-11 |
| 2.4 | 1-244-610-11 | 24 | 1-244-634-11 | 240 | 1-244-658-11 | 2.4k | 1-244-682-11 | 24k | 1-244-706-11 | 240k | 1-244-730-11 | 2.4M | 1-244-754-11 |
| 2.7 | 1-244-611-11 | 27 | 1-244-635-11 | 270 | 1-244-659-11 | 2.7k | 1-244-683-11 | 27k | 1-244-707-11 | 270k | 1-244-731-11 | 2.7M | 1-244-755-11 |
| 3.0 | 1-244-612-11 | 30 | 1-244-636-11 | 300 | 1-244-660-11 | 3.0k | 1-244-684-11 | 30k | 1-244-708-11 | 300k | 1-244-732-11 | 3.0M | 1-244-756-11 |
| 3.3 | 1-244-613-11 | 33 | 1-244-637-11 | 330 | 1-244-661-11 | 3.3k | 1-244-685-11 | 33k | 1-244-709-11 | 330k | 1-244-733-11 | 3.3M | 1-244-757-11 |
| 3.6 | 1-244-614-11 | 36 | 1-244-638-11 | 360 | 1-244-662-11 | 3.6k | 1-244-686-11 | 36k | 1-244-710-11 | 360k | 1-244-734-11 | 3.6M | 1-244-758-11 |
| 3.9 | 1-244-615-11 | 39 | 1-244-639-11 | 390 | 1-244-663-11 | 3.9k | 1-244-687-11 | 39k | 1-244-711-11 | 390k | 1-244-735-11 | 3.9M | 1-244-759-11 |
| 4.3 | 1-244-616-11 | 43 | 1-244-640-11 | 430 | 1-244-664-11 | 4.3k | 1-244-688-11 | 43k | 1-244-712-11 | 430k | 1-244-736-11 | 4.3M | 1-244-760-11 |
| 4.7 | 1-244-617-11 | 47 | 1-244-641-11 | 470 | 1-244-665-11 | 4.7k | 1-244-689-11 | 47k | 1-244-713-11 | 470k | 1-244-737-11 | 4.7M | 1-244-761-11 |
| 5.1 | 1-244-618-11 | 51 | 1-244-642-11 | 510 | 1-244-666-11 | 5.1k | 1-244-690-11 | 51k | 1-244-714-11 | 510k | 1-244-738-11 | 5.1M | 1-244-762-11 |
| 5.6 | 1-244-619-11 | 56 | 1-244-643-11 | 560 | 1-244-667-11 | 5.6k | 1-244-691-11 | 56k | 1-244-715-11 | 560k | 1-244-739-11 | | |
| 6.2 | 1-244-620-11 | 62 | 1-244-644-11 | 620 | 1-244-668-11 | 6.2k | 1-244-692-11 | 62k | 1-244-716-11 | 620k | 1-244-740-11 | | |
| 6.8 | 1-244-621-11 | 68 | 1-244-645-11 | 680 | 1-244-669-11 | 6.8k | 1-244-693-11 | 68k | 1-244-717-11 | 680k | 1-244-741-11 | | |
| 7.5 | 1-244-622-11 | 75 | 1-244-646-11 | 750 | 1-244-670-11 | 7.5k | 1-244-694-11 | 75k | 1-244-718-11 | 750k | 1-244-742-11 | | |
| 8.2 | 1-244-623-11 | 82 | 1-244-647-11 | 820 | 1-244-671-11 | 8.2k | 1-244-695-11 | 82k | 1-244-719-11 | 820k | 1-244-743-11 | | |
| 9.1 | 1-244-624-11 | 91 | 1-244-648-11 | 910 | 1-244-672-11 | 9.1k | 1-244-696-11 | 91k | 1-244-720-11 | 910k | 1-244-744-11 | | |

STEREO CASSETTE DECK

TC-K5

US Model
 Canadian Model
 AEP Model
 E Model
 UK Model

CORRECTION

Correct the service manual as shown below.

No. 2

April, 1979

Page 24

 : corrected portion

SCHEMATIC DIAGRAM

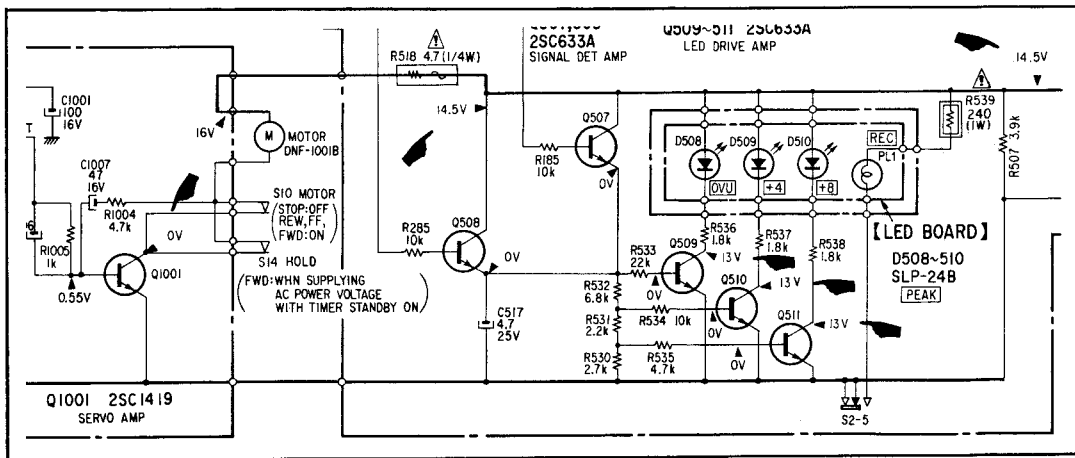

Page 21

MOUNTING DIAGRAM

[REC/PB AMP BOARD]

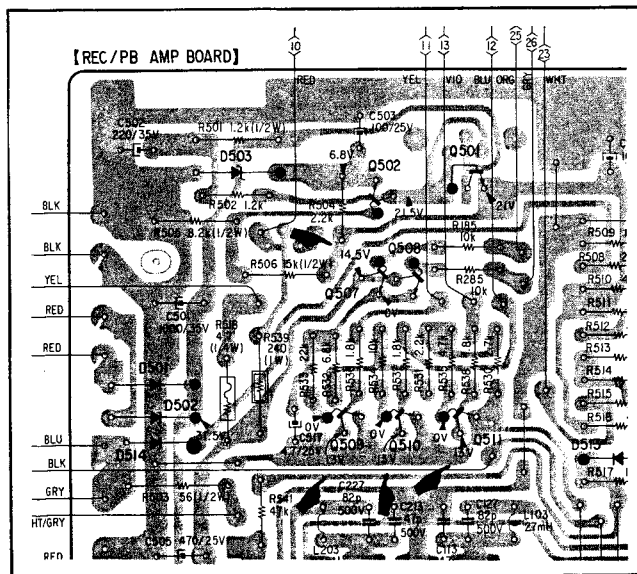



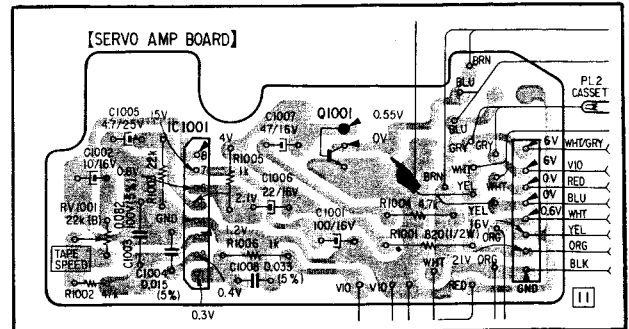





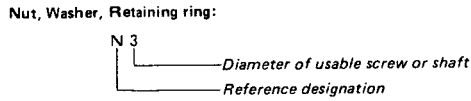
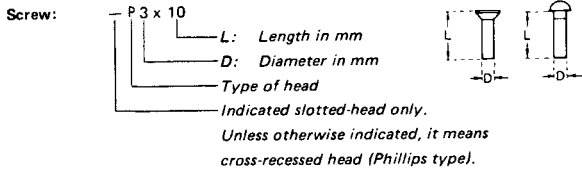



[SERVO AMP BOARD]















SONY
 SERVICE MANUAL

HARDWARE NOMENCLATURE



| Reference Designation | Shape | Description | Remarks |
|-----------------------|-------------------------------------------------------------------------------------|---------------------------------------------|--------------------------------------------------------------------|
| SCREWS | | | |
| P |  | pan-head screw | binding-head (B) screw for replacement |
| PWH |  | pan-head screw with washer face | binding-head (B) screw and flat washer for replacement |
| PS PSP |  | pan-head screw with spring washer | binding-head (B) screw and spring washer for replacement |
| PSW PSPW |  | pan-head screw with spring and flat washers | binding-head (B) screw and spring and flat washers for replacement |
| R |  | round-head screw | binding-head (B) screw for replacement |
| K |  | flat-countersunk-head screw | |
| RK |  | oval-countersunk-head screw | |
| B |  | binding-head screw | |
| T |  | truss-head screw | binding-head (B) screw for replacement |
| F |  | flat-fillister-head screw | |
| RF |  | fillister-head screw | |
| BV |  | braizer-head screw | |

| Reference Designation | Shape | Description | Remarks |
|----------------------------|-------------------------------------------------------------------------------------|------------------------------------------------|-------------------------------------------------------------------------|
| SELF-TAPPING SCREWS | | | |
| TA |  | self-tapping screw | ex: TA, P 3 x 10 |
| PTP |  | pan-head self-tapping screw | binding-head self-tapping (TA, B) screw for replacement |
| PTPWH |  | pan-head self-tapping screw with washer face | binding-head self-tapping (TA, B) screw and flat washer for replacement |
| PTTWH |  | pan-head thread-rolling screw with washer face | binding-head (B) screw and flat washer for replacement |
| SET SCREWS | | | |
| SC |  | set screw | |
| SC |  | hexagon-socket set screw | ex: SC 2.6 x 4, hexagon socket |
| NUT | | | |
| N |  | nut | |
| WASHERS | | | |
| W |  | flat washer | |
| SW |  | spring washer | |
| LW |  | internal-tooth lock washer | ex: LW3, internal |
| LW |  | external-tooth lock washer | ex: LW3, external |
| RETAINING RINGS | | | |
| E |  | retaining ring | |
| G |  | grip-type retaining ring | |